

Agilent 34410A/11A 6 ½ Digit Multimeter

(includes the L4411A 1U DMM)

Service Guide



Agilent Technologies

Notices

© Agilent Technologies, Inc. 2005 - 2007

No part of this manual may be reproduced in any form or by any means (including electronic storage and retrieval or translation into a foreign language) without prior agreement and written consent from Agilent Technologies, Inc. as governed by United States and international copyright laws.

Manual Part Number

34410-90010

Edition

Fourth Edition. February 2007

Printed in Malaysia

Agilent Technologies, Inc.
3501 Stevens Creek Blvd.
Santa Clara, CA 95052 USA

Microsoft® and Windows® are U.S. registered trademarks of Microsoft Corporation.

Software Revision

This guide is valid for the firmware that was installed in the instrument at the time of manufacture. However, upgrading the firmware may add or change product features. For the latest firmware and documentation, go to the product page at:

www.agilent.com/find/34410A

or

www.agilent.com/find/34411A

or

www.agilent.com/find/L4411A

Warranty

The material contained in this document is provided “as is,” and is subject to being changed, without notice, in future editions. Further, to the maximum extent permitted by applicable law, Agilent disclaims all warranties, either express or implied, with regard to this manual and any information contained herein, including but not limited to the implied warranties of merchantability and fitness for a particular purpose. Agilent shall not be liable for errors or for incidental or consequential damages in connection with the furnishing, use, or performance of this document or of any information contained herein. Should Agilent and the user have a separate written agreement with warranty terms covering the material in this document that conflict with these terms, the warranty terms in the separate agreement shall control.

Technology Licenses

The hardware and/or software described in this document are furnished under a license and may be used or copied only in accordance with the terms of such license.

Restricted Rights Legend

U.S. Government Restricted Rights. Software and technical data rights granted to the federal government include only those rights customarily provided to end user customers. Agilent provides this customary commercial license in Software and technical data pursuant to FAR 12.211 (Technical Data) and 12.212 (Computer Software) and, for the Department of Defense, DFARS 252.227-7015 (Technical Data - Commercial Items) and DFARS 227.7202-3 (Rights in Commercial Computer Software or Computer Software Documentation).

Safety Notices

CAUTION

A **CAUTION** notice denotes a hazard. It calls attention to an operating procedure, practice, or the like that, if not correctly performed or adhered to, could result in damage to the product or loss of important data. Do not proceed beyond a **CAUTION** notice until the indicated conditions are fully understood and met.

WARNING

A **WARNING** notice denotes a hazard. It calls attention to an operating procedure, practice, or the like that, if not correctly performed or adhered to, could result in personal injury or death. Do not proceed beyond a **WARNING** notice until the indicated conditions are fully understood and met.

Safety Information

Do not defeat power cord safety ground feature. Plug in to a grounded (earthed) outlet.

Do not use product in any manner not specified by the manufacturer.

Do not install substitute parts or perform any unauthorized modification to the product. Return the product to an Agilent Technologies Sales and Service Office for service and repair to ensure that safety features are maintained.

Safety Symbols



Earth Ground



Chassis Ground



Risk of electric shock



Refer to manual for additional safety information

CAT II (300V) IEC Measurement Category II. Inputs may be connected to mains (up to 300 VAC) under Category II overvoltage conditions.

WARNING

Main Power and Test Input Disconnect: Unplug instrument from wall outlet, remove power cord, and remove all probes from all terminals before servicing. Only qualified, service-trained personnel should remove the cover from the instrument.

WARNING

Line and Current Protection Fuses: For continued protection against fire, replace the line fuse and the current-protection fuse only with fuses of the specified type and rating.

WARNING

Front/Rear Switch: Do not change the position of the Front/Rear switch on the front panel while signals are present on either the front or rear set of terminals. The switch is not intended as an active multiplexer. Switching while high voltages or currents are present may cause instrument damage and lead to the risk of electric shock.

WARNING

IEC Measurement Category II. The HI and LO input terminals may be connected to mains in IEC Category II installations for line voltages up to 300 VAC. To avoid the danger of electric shock, do not connect the inputs to mains for line voltages above 300 VAC. See "IEC Measurement Category II Overvoltage Protection" on the following page for further information.

WARNING

Protection Limits: To avoid instrument damage and the risk of electric shock, do not exceed any of the Protection Limits defined in the following section.

Protection Limits

The Agilent 34410A/11A Digital Multimeter provides protection circuitry to prevent damage to the instrument and to protect against the danger of electric shock, provided the Protection Limits are not exceeded. To ensure safe operation of the instrument, do not exceed the Protection Limits shown on the front and rear panel, and defined below:

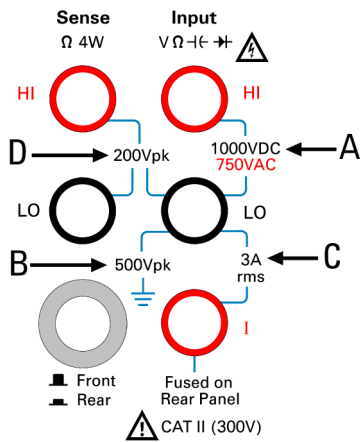

Note: The front-panel terminals are shown above. The rear-panel terminals are identical. The Front/Rear switch selects the terminal set to be used. *Do not operate this switch while signals are present on the front or rear terminals.* The current-protection fuse is on the rear panel.

Input Terminal Protection Limits

Protection Limits are defined for the input terminals:

Main Input (HI and LO) Terminals. The HI and LO input terminals are used for voltage, resistance, capacitance, and diode test measurements. Two Protection Limits are defined for these terminals:

HI to LO Protection Limit. The Protection Limit from HI to LO ("A" in the figure at left) is 1000 VDC or 750 VAC, which is also the maximum voltage measurement. This limit can also be expressed as 1000 Vpk maximum.

LO to Ground Protection Limit. The LO input terminal can safely "float" a maximum of 500 Vpk relative to ground. This is Protection Limit "B" in the figure.

As is implied by the above limits, the Protection Limit for the HI input terminal is a maximum of 1500 Vpk relative to ground.

Current Input Terminal. The current input ("I") terminal has a Protection Limit of 3A (rms) maximum current flowing from the LO input terminal. This is Protection Limit "C" in the figure. Note that the current input terminal will be at approximately the same voltage as the LO terminal.

Note: The current-protection circuitry includes a fuse on the rear panel. To maintain protection, replace this fuse only with a fuse of the specified type and rating.

Sense Terminal Protection Limits

The HI and LO sense terminals are used only for four-wire resistance and temperature measurements ("Ω 4W"). The Protection Limit is 200 Vpk for all of the terminal pairings ("D" in the figure):

- LO sense to LO input.
- HI sense to LO input.
- HI sense to LO sense.

Note: The 200 Vpk limit on the sense terminals is the Protection Limit. Operational voltages in resistance measurements are much lower — less than 10 V in normal operation.

IEC Measurement Category II Overvoltage Protection

To protect against the danger of electric shock, the Agilent 34410A/11A Digital Multimeter provides overvoltage protection for line-voltage mains connections meeting **both** of the following conditions:

The HI and LO input terminals are connected to the mains under Measurement Category II conditions, defined below, **and**

The mains are limited to a maximum line voltage of 300 VAC.

IEC Measurement Category II includes electrical devices connected to mains at an outlet on a branch circuit. Such devices include most small appliances, test equipment, and other devices that plug into a branch outlet or socket. The 34410A/11A may be used to make measurements with the HI and LO inputs connected to mains in such devices, or to the branch outlet itself (up to 300 VAC). However, the 34410A/11A may not be used with its HI and LO inputs connected to mains in permanently installed electrical devices such as the main circuit-breaker panel, sub-panel disconnect boxes, or permanently wired motors. Such devices and circuits are subject to overvoltages that may exceed the protection limits of the 34410A/11A.

Note: Voltages above 300 VAC may be measured only in circuits that are isolated from mains. However, transient overvoltages are also present on circuits that are isolated from mains. The Agilent 34410A/11A is designed to safely withstand occasional transient overvoltages up to 2500 Vpk. Do not use this equipment to measure circuits where transient overvoltages could exceed this level.

Additional Notices

Waste Electrical and Electronic Equipment (WEEE) Directive 2002/96/EC

This product complies with the WEEE Directive (2002/96/EC) marking requirement. The affixed product label (see below) indicates that you must not discard this electrical/electronic product in domestic household waste.

Product Category: With reference to the equipment types in the WEEE directive Annex 1, this product is classified as a "Monitoring and Control instrumentation" product.

Do not dispose in domestic household waste.

To return unwanted products, contact your local Agilent office, or see www.agilent.com/environment/product for more information.



Agilent 34138A Test Lead Set

The Agilent 34410A/11A is provided with an Agilent 34138A Test Lead Set, described below.

Test Lead Ratings

Test Leads - 1000V, 15A

Fine Tip Probe Attachments - 300V, 3A

Mini Grabber Attachment - 300V, 3A

SMT Grabber Attachments - 300V, 3A

Operation

The Fine Tip, Mini Grabber, and SMT Grabber attachments plug onto the probe end of the Test Leads.

Maintenance

If any portion of the Test Lead Set is worn or damaged, do not use. Replace with a new Agilent 34138A Test Lead Set.

WARNING

If the Test Lead Set is used in a manner not specified by Agilent Technologies, the protection provided by the Test Lead Set may be impaired. Also, do not use a damaged or worn Test Lead Set. Instrument damage or personal injury may result.



Agilent Technologies

DECLARATION OF CONFORMITY
According to EN ISO/IEC 17050-1:2004



Manufacturer's Name: Agilent Technologies, Incorporated
Manufacturer's Address: 900 South Taft Ave
Loveland, CO 80537
USA

Declares under sole responsibility that the product as originally delivered

Product Name: 6 ½ Digit Multimeter
Model Number: 34410A, 34411A, L4411A
Product Options: This declaration covers all options of the above product(s)

complies with the essential requirements of the following applicable European Directives, and carries the CE marking accordingly:

Low Voltage Directive (73/23/EEC, amended by 93/68/EEC)
EMC Directive (89/336/EEC, amended by 93/68/EEC)

and conforms with the following product standards:

EMC	Standard	Limit
	IEC 61326:2002 / EN 61326:1997+A1:1998 +A2:2000+A3:2003	
	<i>Reference Standards</i>	
	CISPR 11:1990 / EN 55011:1990	Class A Group 1
	IEC 61000-4-2:1995 / EN 61000-4-2:1995	4 kV/4 kV contact/air
	IEC 61000-4-3:1995 / EN 61000-4-3:1995	3 V/m, 80-1000 MHz
	IEC 61000-4-4:1995 / EN 61000-4-4:1995	0.5 kV signal lines, 1 kV power lines
	IEC 61000-4-5:1995 / EN 61000-4-5:1995	0.5 kV line-line, 1 kV line-ground
	IEC 61000-4-6:1996 / EN 61000-4-6:1996	3 V, 0.15-80 MHz
	IEC 61000-4-11:1994 / EN 61000-4-11:1994	1 cycle, >95%
	Canada: ICES-001:2004	
	Australia/New Zealand: AS/NZS CISPR 11:2002	

The product was tested in a typical configuration with Agilent Technologies test systems.

Safety IEC 61010-1:2001 / EN 61010-1:2001
Canada: CAN/CSA-C22.2 No. 61010-1-04,  168520
USA: ANSI/UL 61010-1:2005

Supplementary Information:

This DoC applies to above-listed products placed on the EU market after:

17 January 2007
Date

David L. Kepler
Quality Manager

For further information, please contact your local Agilent Technologies sales office, agent or distributor, or Agilent Technologies Deutschland GmbH, Herrenberger Straße 130, D 71034 Böblingen, Germany.

Agilent 34410A/11A/L4411A at a Glance

The Agilent 34410A, 34411A, or L4411A multimeter provides 6½-digit, high-performance dc and ac measurements.

- **Voltage and Current Measurements.** DC and AC_(true-rms).
- **Resistance Measurements.** 2-wire and 4-wire.
- **Continuity and Diode Testing.**
- **Frequency and Period Measurements.**
- **Capacitance Measurements.**
- **Temperature Measurements.** Thermistor and RTD.
- **Auto and Manual Ranging.**
- **Math Features.** Null, dB, dBm, limits, and statistics.
- **Data Logging.** Into *non-volatile* instrument memory.
- **Instrument State Storage.** User-defined named states.
- **GPIB (IEEE-488), USB, and LAN.** Three standard remote interfaces. *LXI Class C Compliant.*
- **Web Interface.** Direct web browser access to instrument.
- **SCPI Compatibility.** For easy instrument programming.
- **Voltmeter Complete and External Trigger Signals.**
Synchronize with other instruments in your test system.

Note: This manual covers the operation of the Agilent 34410A, 34411A, and L4411A 6½ Digit Multimeters. The features described in this manual, except where otherwise noted, apply to the 34410A, 34411A, and L4411A.

Key Differences:

Model 34410A	Model 34411A/L4411A
• Up to 10,000 readings per second.	• Up to 50,000 readings per second.
• Reading memory (buffer) up to 50,000 readings.	• Reading memory (buffer) up to 1 million readings.
	• Pretriggering, internal level triggering, and digitizer specifications.

The Front Panel at a Glance

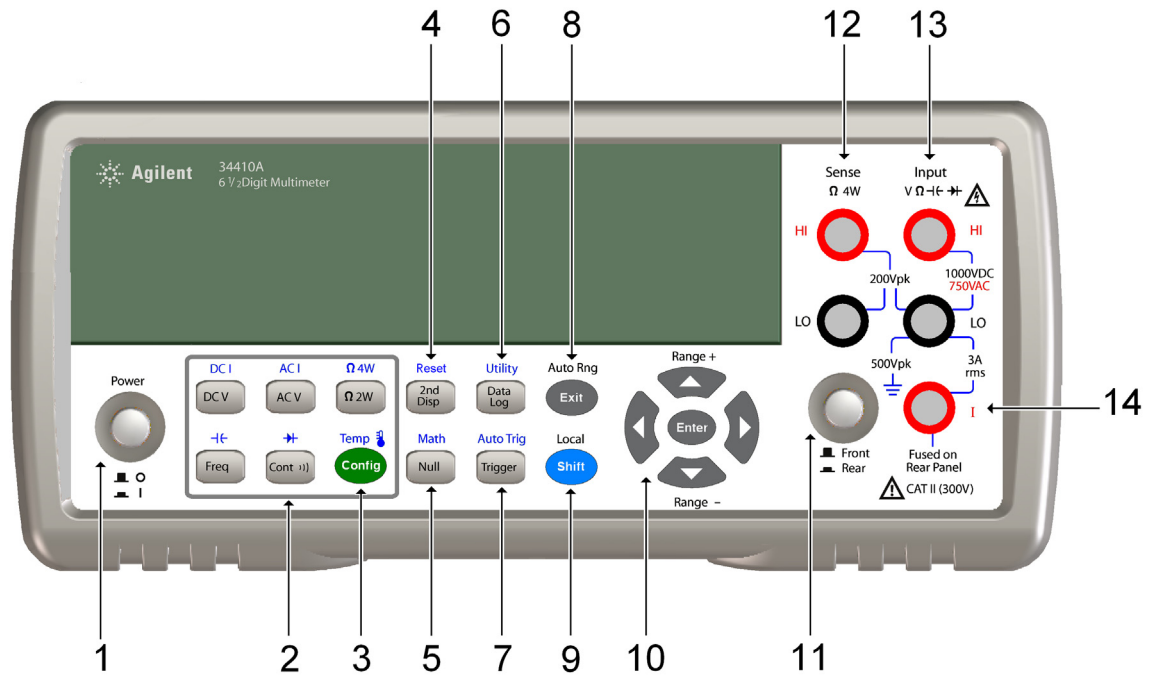

- | | |
|------------------------------|---|
| 1 On/Off Switch | 8 Exit Key (Auto Range) |
| 2 Measurement Function Keys | 9 Shift Key (Local) |
| 3 Configuration Key | 10 Menu Navigation Keypad (Range) |
| 4 Second Display Key (Reset) | 11 Front/Rear Switch |
| 5 Null Key (Math Functions) | 12 HI and LO Sense Terminals (4-wire measurements) |
| 6 Data Logger Key (Utility) | 13 HI and LO Input Terminals (all functions except current) |
| 7 Trigger Key (Auto Trig) | 14 Current Input Terminal (ac and dc current) |

WARNING

Front/Rear Switch: Do not change the position of the Front/Rear switch on the front panel while signals are present on either the front or rear set of terminals. This switch is not intended as an active multiplexer. Switching while high voltages or currents are present may cause instrument damage and lead to the risk of electric shock.

The Rear Panel at a Glance

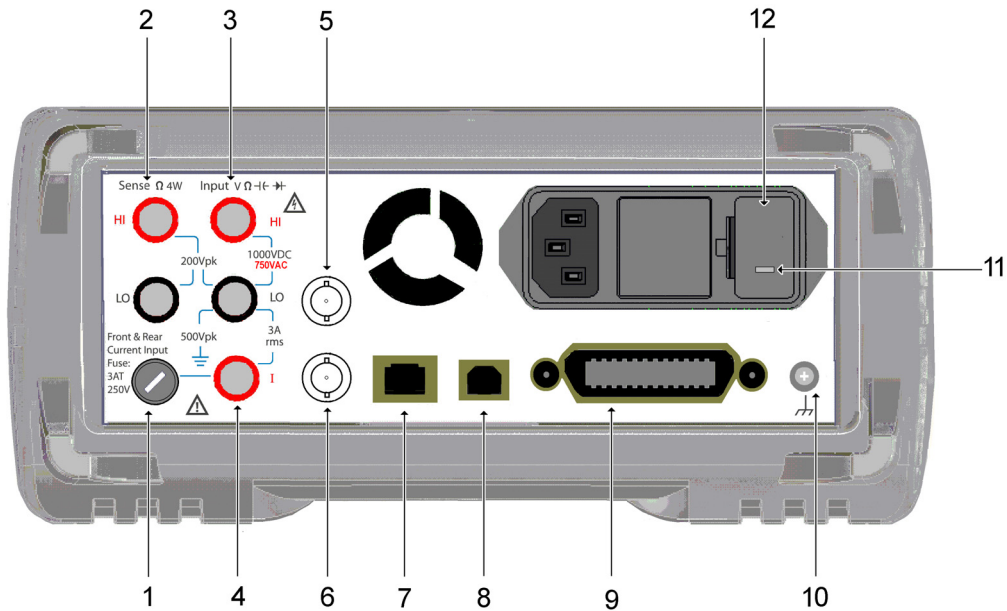

- 1 Current Input Fuse (front and rear)
- 2 HI and LO Sense Terminals (4-wire resistance and temperature)
- 3 HI and LO Input Terminals (voltage, resistance, and other functions)
- 4 Current Input Terminal (ac current and dc current only)
- 5 External Trigger Input (BNC)
- 6 Voltmeter Complete Output (BNC)
- 7 LAN Interface Connector
- 8 USB Interface Connector
- 9 GPIB Interface Connector
- 10 Chassis Ground
- 11 Power-Line Voltage Setting
- 12 Power-Line Fuse-Holder Assembly

WARNING

For protection from electrical shock, the power cord ground must not be defeated. For continued protection from fire, replace fuses only with fuses of the specified type and rating.

The Display at a Glance

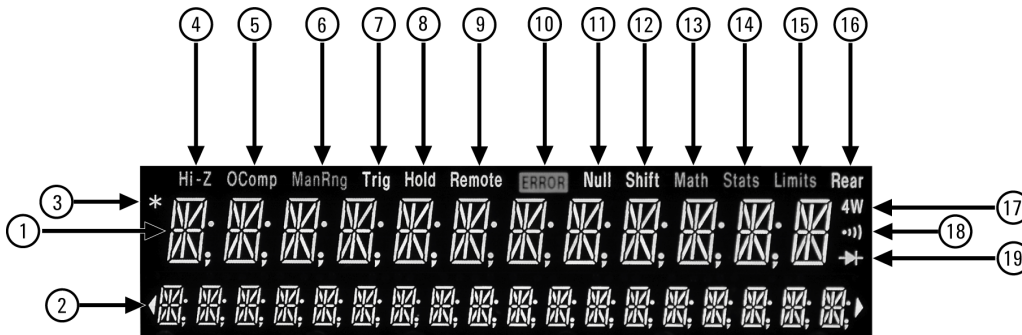

Alphanumeric Displays:

- 1 Primary display line
- 2 Secondary display line

Annunciators:

- 3 * (measurement in progress)
- 4 **Hi-Z** (high input impedance, Vdc only)
- 5 **OComp** (offset compensation)
- 6 **ManRng** (manual ranging)
- 7 **Trig** (wait-for-trigger state)
- 8 **Hold** (reading hold)
- 9 **Remote** (remote interface operation)
- 10 **Error** (error in queue)
- 11 **Null** (null function enabled)

Annunciators:

- 12 **Shift** (shift key just pressed)
- 13 **Math** (dB or dBm function enabled)
- 14 **Stats** (statistics functions enabled)
- 15 **Limits** (limit-test function enabled)
- 16 **Rear** (rear-panel terminals active)
- 17 **4W** (four-wire ohms or temperature)
- 18))) (continuity test function enabled)
- 19 >| (diode-check function enabled)

The following key refers to the primary front-panel display.

-H.DDD,DDD EFFF

Front-panel display format.

- Negative sign or blank (positive)
- H " 1/2 " digit (0 or 1)
- D Numeric digits
- E Exponent (m, k, M)
- F Measurement units (VDC, OHM, HZ, dB)

For further information, see Chapter 2, "Features and Functions" in the *Agilent 34410A/11A User's Guide*.

The L4411A at a Glance

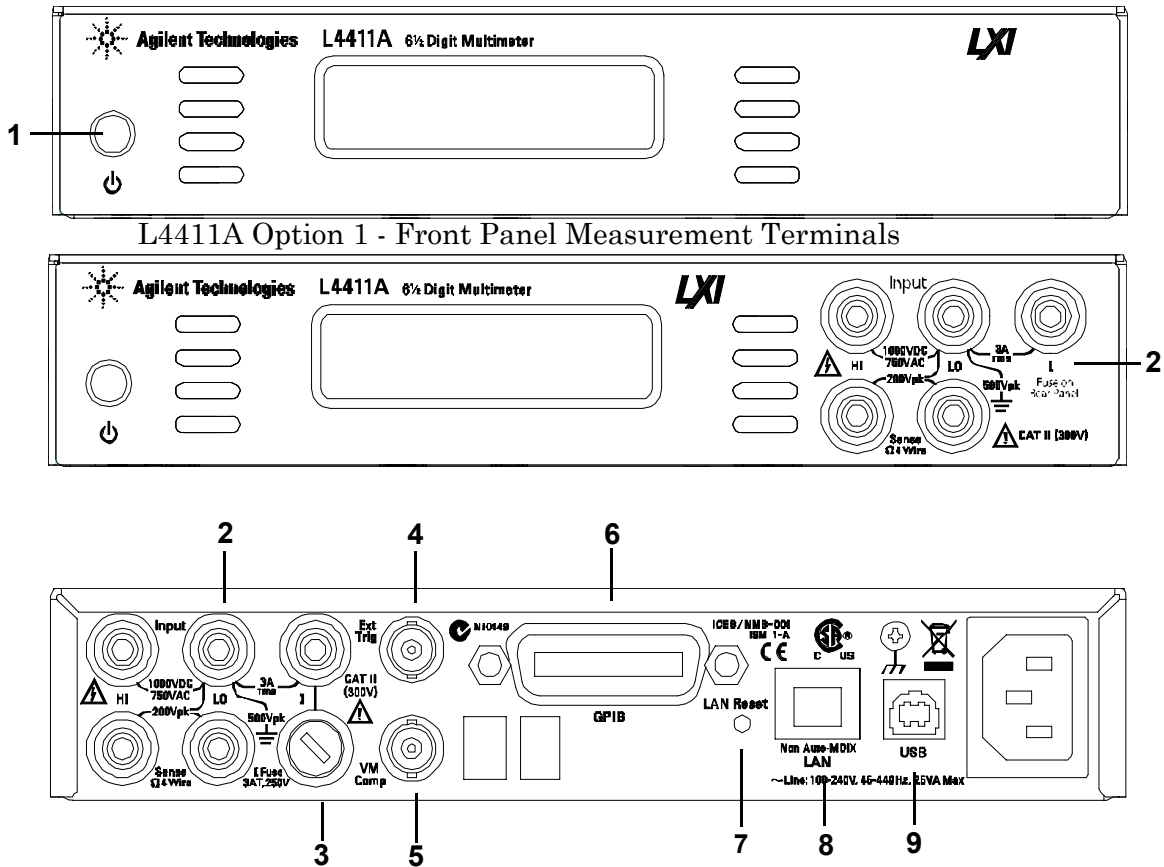

- 1 On/Stand-By button
- 2 Input measurement terminals - rear panel or front panel (optional)
- 3 Input current protection fuse (Agilent p/n 2110-0780)
- 4 External trigger input - BNC
- 5 Voltmeter (measurement) complete output - BNC
- 6 GPIB interface connector
- 7 LAN Reset - resets the L4411A LAN configuration to its factory default settings
- 8 LAN Interface connector - non Auto-MDIX; may require crossover cable (included)
- 9 High-Speed USB interface connector (type B)

In This Guide...

1 Specifications

This chapter lists the multimeter's specifications and describes how to interpret these specifications.

2 Quick Start

This chapter prepares the multimeter for use and helps you get familiar with a few of the front panel features.

3 Calibration

This chapter provides calibration, verification, and adjustment procedures for the multimeter.

4 Disassembly and Repair

This chapter provides guidelines for returning the multimeter to Agilent Technologies for servicing, or for servicing it yourself. The chapter includes disassembly instructions and a list of replaceable parts.

5 Backdating

This chapter describes the differences between this guide and older versions of this guide.

Contents

1	Specifications	17
	DC Characteristics	19
	AC Characteristics	22
	Frequency and Period Characteristics	24
	Capacitance Characteristics	26
	Temperature Characteristics	26
	Additional 34411A/L4411A Specifications	27
	Measurement and System Speeds	28
	System Speeds	29
	Data From Memory	30
	General Specifications	30
	Dimensions	32
	To Calculate Total Measurement Error	33
	Interpreting Accuracy Specifications	35
	Transfer Accuracy	35
	24–Hour Accuracy	35
	90–Day and 1–Year Accuracy	35
	Temperature Coefficients	35
	Configuring for Highest Accuracy Measurements	36
	DC Voltage, DC Current, and Resistance Measurements:	36
	AC Voltage and AC Current Measurements:	36
	Frequency and Period Measurements:	36

2	Quick Start	37
	Basic Multimeter Operations	38
	Preparing the Multimeter for Use	38
	Using the Front Panel	39
	Front-Panel Keys	39
	Front-Panel Display Shortcuts	40
	Making Basic Measurements	41
	To Measure DC Voltage	42
	To Measure AC Voltage	42
	To Measure DC Current	43
	To Measure AC Current	43
	To Make a 2-Wire Resistance Measurement	44
	To Make a 4-wire Resistance Measurement	44
	To Measure Frequency	45
	To Measure Period	45
	To Measure Capacitance	46
	To Make a 2-Wire Temperature Measurement	47
	To Make a 4-Wire Temperature Measurement	47
	To Test Continuity	48
	To Check Diodes	48
	Other Basics of Operation	49
	If the Multimeter Does Not Turn On	49
	To Replace the Power-Line Fuse (34410A/11A)	50
	To Adjust the Carrying Handle (34410A/11A)	51
	To Rack Mount the 34410A/11A Multimeter	51
	To Rack Mount the L4411A Multimeter	52
	Calibration Operation (34410A/11A)	53
	To Read the Calibration Count	53
	To Read the Calibration Message	54
	To Store a Calibration Message	54
	To Secure for Calibration	55
	To Unsecure for Calibration	56
	To Re-secure	56

3	Calibration Procedures	57
	Agilent Technologies Calibration Services	58
	Calibration Interval	58
	Adjustment is Recommended	58
	Time Required for Calibration	59
	Automating Calibration Procedures	59
	Recommended Test Equipment	60
	Performance Verification Tests	60
	Self-Test	61
	Quick Performance Check	61
	Performance Verification Tests	62
	Input Connections	62
	Test Considerations	63
	Verification Tests	64
	Zero Offset Verification	64
	Gain Verification	66
	Optional AC Voltage Performance Verification Tests	72
	Optional AC Current Performance Verification Tests	73
	Optional Capacitance Performance Verification Tests	74
	Calibration Security	75
	To Unsecure the Instrument Without the Security Code	75
	Calibration Message	77
	Calibration Count	77
	Calibration Process	78
	Using the Front Panel for Adjustments (34410A/11A Only)	78
	Selecting the Adjustment Mode	78
	Entering Adjustment Values	78
	Storing the Calibration Constants	78
	Using the Remote Interface for Adjustments	79
	Selecting the Adjustment Mode	79
	Entering Adjustment Values	79
	Storing the Calibration Constants	79
	Aborting a Calibration in Progress	79
	Adjustments	80
	ADC and Zero Adjustment	80
	Gain Adjustments	82
	Flatness Adjustments	93
	Finishing Adjustments	102

4	Disassembly and Repair	103
	Operating Checklist	104
	Types of Service Available	105
	Extended Service Contracts	105
	Obtaining Repair Service (Worldwide)	105
	Repackaging for Shipment	106
	Cleaning	106
	To Replace the 34410A/11A Power Line Fuse	106
	To Replace the Current Input Fuse	107
	Self Test Procedures	107
	Power-On Self-Test	107
	34410A/11A Complete Self-Test	107
	L4411A Complete Self-Test	107
	Self Test Error Numbers	108
	Calibration Errors	109
	34410A/11A Display and Keypad Tests	110
	Electrostatic Discharge (ESD) Precautions	110
	34410A/11A Mechanical Disassembly	111
	General Disassembly	111
	Front Panel Removal	113
	Front Panel Disassembly	116
	L4411A Mechanical Disassembly	117
	General Disassembly	117
	Replaceable Parts	122
	To Order Replaceable Parts	122
	Parts List 34410A/11A	123
	Parts List L4411A	124
5	Backdating	125



1 Specifications

DC Characteristics	19
AC Characteristics	22
Frequency and Period Characteristics	24
Capacitance Characteristics	26
Temperature Characteristics	26
Additional 34411A/L4411A Specifications	27
Measurement and System Speeds	28
General Specifications (34410A/11A)	30
Dimensions	32
To Calculate Total Measurement Error	33
Interpreting Accuracy Specifications	35
Configuring for Highest Accuracy Measurements	36



1 Specifications

These specifications apply when using the 34410A/11A/L4411A multimeter in an environment that is *free* of electromagnetic interference and electrostatic charge.

When using the multimeter in an environment where electromagnetic interference or significant electrostatic charge *is* present, measurement accuracy may be reduced. *Particularly note:*

- The voltage measurement probes are not shielded and can act as antennas, causing electromagnetic interference to be added to the signal being measured.
- Electrostatic discharges of 4000 V or greater may cause the multimeter to temporarily stop responding, resulting in a lost or erroneous reading.

NOTE

The specifications on the following pages are valid for Agilent 34410A, 34411A, or L4411A multimeters with firmware revision 2.05, or later, installed.

Specifications are subject to change without notice. For the latest specifications, see the product datasheet on the Web. Firmware updates may also be available on the Web. Start at the appropriate product page:

www.agilent.com/find/34410A

www.agilent.com/find/34411A

www.agilent.com/find/L4411A

This ISM device complies with Canadian ICES-001.

Cet appareil ISM est conforme à la norme NMB-001 du Canada.



DC Characteristics

Accuracy Specifications (% of reading + % of range)^[1]

Function	Range ^[3]	Test Current or Burden Voltage	24 Hour ^[2] T _{CAL} ± 1 °C	90 Day T _{CAL} ± 5 °C	1 Year T _{CAL} ± 5 °C	Temperature Coefficient 0 °C to (T _{CAL} - 5 °C) (T _{CAL} + 5 °C) to 55 °C
DC	100.0000 mV		0.0030+0.0030	0.0040+0.0035	0.0050+0.0035	0.0005+0.0005
	1.000000 V		0.0020+0.0006	0.0030+0.0007	0.0035+0.0007	0.0005+0.0001
	10.00000 V		0.0015+0.0004	0.0020+0.0005	0.0030+0.0005	0.0005+0.0001
	100.0000 V		0.0020+0.0006	0.0035+0.0006	0.0040+0.0006	0.0005+0.0001
	1000.000 V ^[5]		0.0020+0.0006	0.0035+0.0006	0.0040+0.0006	0.0005+0.0001
Resistance^[4]	100.0000 Ω	1 mA Current Source	0.0030+0.0030	0.008+0.004	0.010+0.004	0.0006+0.0005
	1.000000 KΩ	1 mA	0.0020+0.0005	0.007+0.001	0.010+0.001	0.0006+0.0001
	10.00000 KΩ	100 μA	0.0020+0.0005	0.007+0.001	0.010+0.001	0.0006+0.0001
	100.0000 KΩ	10 μA	0.0020+0.0005	0.007+0.001	0.010+0.001	0.0006+0.0001
	1.000000 MΩ	5.0 μA	0.0020+0.0010	0.010+0.001	0.012+0.001	0.0010+0.0002
	10.00000 MΩ	500 nA	0.0100+0.0010	0.030+0.001	0.040+0.001	0.0030+0.0004
	100.0000 MΩ	500 nA 10 MΩ	0.200+0.001	0.600+0.001	0.800+0.001	0.1000+0.0001
	1000.000 MΩ	500 nA 10 MΩ	2.000+0.001	6.000+0.001	8.000+0.001	1.0000+0.0001
DC Current	100.0000 μA	<0.03 V Burden V	0.010+0.020	0.040+0.025	0.050+0.025	0.0020+0.0030
	1.000000 mA	<0.3 V	0.007+0.006	0.030+0.006	0.050+0.006	0.0020+0.0005
	10.00000 mA	<0.03 V	0.007+0.020	0.030+0.020	0.050+0.020	0.0020+0.0020
	100.0000 mA	<0.3 V	0.010+0.004	0.030+0.005	0.050+0.005	0.0020+0.0005
	1.000000 A	<0.80 V	0.050+0.006	0.080+0.010	0.100+0.010	0.0050+0.0010
	3.00000 A	<2.0 V	0.100+0.020	0.120+0.020	0.150+0.020	0.0050+0.0020
Continuity	1000 Ohms	1 mA Test Current	0.002+0.010	0.008+0.020	0.010+0.020	0.0010+0.0020
Diode Test	1.0000 V ^[6]	1 mA Test Current	0.002+0.010	0.008+0.020	0.010+0.020	0.0010+0.0020

[1] Specifications are for 90 minute warm-up and integration setting of 100 NPLC.

For <100 NPLC, add the appropriate "RMS Noise Adder" from the table on the following page.

[2] Relative to calibration standards.

[3] 20% overrange on all ranges, except 1000 Vdc, 3 A range.

[4] Specifications are for 4-wire ohms function, or 2-wire ohms using Math Null. Without Math Null, add 0.2 Ω additional error in 2-wire ohms function.

[5] For each additional volt over ± 500 VDC add 0.02 mV of error.

[6] Accuracy specifications are for the voltage measured at the input terminals only. 1 mA test current is typical. Variation in the current source will create some variation in the voltage drop across a diode junction.

1 Specifications

Performance Versus Integration Time – 60Hz (50Hz) Power line frequency

Integration Time Number of Power Line Cycles (NPLC)	Resolution ppm Range ^[1]	NMR db ^[2]	Readings / Second ^[3]	RMS Noise Adder % range ^[4]		
				DCV 10, 1000 V	DCV 1, 100 V Resistance 1K, 10K ohm	DCV 0.1 V Resistance 100 ohm DCI 1 amp
0.001 ^[6]	30	0	50,000	0.0060	0.0100	0.1000
0.002 ^[6]	15	0	25,000	0.0030	0.0060	0.0600
0.006	6	0	10,000	0.0012	0.0040	0.0600
0.02	3	0	3000	0.0006	0.0030	0.0300
0.06	1.5	0	1000	0.0003	0.0020	0.0200
0.2	0.7	0	300	0.0002	0.0015	0.0150
1	0.3	55	60(50)	0.0	0.0001	0.0010
2	0.2	110 ^[5]	30(25)	0.0	0.0001	0.0010
10	0.1	110 ^[5]	6(5)	0.0	0.0	0.0005
100	0.03	110 ^[5]	0.6(0.5)	0.0	0.0	0.0

[1] Resolution is defined as the typical 10 VDC range RMS noise.

[2] Normal mode rejection for power-line frequency $\pm 0.1\%$.

[3] Maximum rate for DCV, DCI, and 2-Wire resistance functions (using zero settling delay, autozero off, etc.).

[4] Autozero on for $\Rightarrow 1$ NPLC.

Basic dc accuracy specifications (previous page) include RMS noise at 100 NPLC.

For <100 NPLC, add appropriate "RMS Noise Adder" to basic accuracy specification.

[5] For power-line frequency $\pm 1\%$ 75 dB and for $\pm 3\%$ 55 dB.

[6] Only for 34411A /L4411A.

Transfer Accuracy (Typical)

All DC volts, <0.12 A DC Current, < 1.2 M Ω : (24 hour % of range error) / 2)

All other DC current and resistance: (24 hour % of range error + % of reading)/2

Conditions: - Within 10 minutes and ± 0.5 °C

- Within $\pm 10\%$ of initial value.

- Following a 2-hour warm-up.

- Fixed range.

- Using ≥ 10 NPLC.

- Measurements are made using accepted metrology practices.

DC Voltage

Measurement Method:	Continuously integrating multi-slope IV
10 VDC Linearity:	0.0002% of reading + 0.0001% of range
Input Resistance:	
0.1 V, 1 V, 10 V Ranges	Selectable 10 M Ω or >10 G Ω (For these ranges, inputs beyond ± 17 V are clamped through 100 k Ω typical)
100 V, 1000 V Ranges	10 M Ω $\pm 1\%$
Input Bias Current:	< 50 pA at 25 °C
Input Terminals:	Copper alloy
Input Protection:	1000 V
DC CMRR	140 dB for 1 k Ω unbalance in LO lead. ± 500 VDC maximum

Resistance

Measurement Method:	Selectable 4-wire or 2-wire ohms.
Max. Lead Resistance (4-wire ohms)	10% of range per lead for 100 Ω , 1 k Ω ranges. 1 k Ω per lead on all other ranges
Input Protection:	1000 V on all ranges
Offset Compensation:	Selectable on the 100 Ω , 1 k Ω , and 10 k Ω ranges

DC Current

Shunt Resistor:	0.1 Ω for 1 A, 3 A. 2 Ω for 10 mA, 100 mA. 200 Ω for 100 μ A, 1 mA.
Input Protection:	Externally accessible 3 A, 250 V fuse

Continuity / Diode Test

Response Time:	300 samples / sec with audible tone
Continuity Threshold:	Fixed at 10 Ω

Autozero OFF Operation (Typical)

Following instrument warm-up at a stable ambient temperature ± 1 °C and <5 minutes. Add 0.0002% of range + 2 μ V for DCV or + 2 m Ω for resistance.

Settling Considerations

Reading settling times are affected by source impedance, cable dielectric characteristics, and input signal changes. Default delays are selected to give first reading right for most measurements.

Measurement Considerations

Agilent recommends the use of Teflon or other high-impedance, low-dielectric absorption wire insulation for these measurements.

AC Characteristics

Accuracy Specifications (% of reading + % of range) ^[1]

Function	Range ^[3]	Frequency Range	24 Hour ^[2] T _{CAL} ± 1 °C	90 Day T _{CAL} ± 5 °C	1 Year T _{CAL} ± 5 °C	Temperature Coefficient 0 °C to (T _{CAL} – 5 °C) (T _{CAL} + 5 °C) to 55 °C
True RMS AC Voltage ^[4]	100.0000 mV to 750.000 V	3 Hz – 5 Hz	0.50 + 0.02	0.50 + 0.03	0.50 + 0.03	0.010 + 0.003
		5 Hz – 10 Hz	0.10 + 0.02	0.10 + 0.03	0.10 + 0.03	0.008 + 0.003
	750.000 V	10 Hz – 20 kHz	0.02 + 0.02	0.05 + 0.03	0.06 + 0.03	0.005 + 0.003
		20 kHz – 50 kHz	0.05 + 0.04	0.09 + 0.05	0.10 + 0.05	0.010 + 0.005
		50 kHz – 100 kHz	0.20 + 0.08	0.30 + 0.08	0.40 + 0.08	0.020 + 0.008
		100 kHz – 300 kHz	1.00 + 0.50	1.20 + 0.50	1.20 + 0.50	0.120 + 0.020
True RMS AC Current ^[5]	100.0000µA to 3.00000A	3 Hz – 5 kHz	0.10 + 0.04	0.10 + 0.04	0.10 + 0.04	0.015 + 0.006
		5 kHz – 10 kHz	0.20 + 0.04	0.20 + 0.04	0.20 + 0.04	0.030 + 0.006

[1] Specifications are for 90 minute warm-up, slow ac filter, sinewave.

[2] Relative to calibration standards.

[3] 20% overrange on all ranges, except 750 Vac, 3 A range.

[4] Specifications are for sinewave input >0.3% of range and > 1mVrms.

Add 30 µV error to AC voltage specification for frequencies < 1kHz.

750 VAC range limited to 8 x 10⁷ Volt-Hz.

750 VAC range add 0.7 mV of error for each additional volt over 300 VAC.

[5] Specifications are for sinewave input >1% of range and > 10 µArms.

Specifications for the 100 µA, 1 mA, 1 A and 3 A ranges are *typical* for frequencies above 5 kHz.

For the 3 A range (all frequencies) add 0.05% of reading + 0.02% of range to listed specifications.

Low Frequency Performance

Three filter settings are available: 3 Hz, 20 Hz, 200Hz.

Frequencies greater than these filter settings are specified with no additional errors.

AC Current Burden Voltage

ACI Ranges	Voltage
100.0000 µA	<0.03 V
1.000000 mA	<0.3 V
10.00000 mA	<0.03 V
100.0000 mA	<0.3 V
1.000000 A	<0.8 V
3.00000 A	<2.0 V

Voltage Transfer Accuracy (typical)

Frequency	Error
10 Hz to 300 kHz	(24 hour % of range + % of reading)/5
Conditions:	<ul style="list-style-type: none"> - Sinewave input only using slow filter. - Within 10 minutes and ± 0.5 °C. - Within $\pm 10\%$ of initial voltage and $\pm 1\%$ of initial frequency. - Following a 2-hour warm-up. - Fixed range between 10% and 100% of full scale (and <120 V). - Measurements are made using accepted metrology practices

True RMS AC Voltage

Measurement Type	AC-coupled True RMS. Measures the AC component of the input.
Measurement Method:	Digital sampling with anti-alias filter.
AC Common Mode Rejection	70 dB For 1 k Ω unbalanced in LO lead and <60 Hz. ± 500 V peak maximum.
Maximum Input:	400 Vdc, 1100 Vpeak
Input Impedance:	1 M Ω \pm 2%, in parallel with <150 pF
Input Protection:	750 V rms all ranges

True RMS AC Current

Measurement Type:	Directly coupled to the fuse and shunt. AC-coupled True RMS measurement (measure the AC component only).
Measurement Method:	Digital sampling with anti-alias filter.
Maximum Input:	The peak value of the DC + AC current must be <300% of range. The RMS current <3 A including the DC current content.
Shunt Resistor:	0.1 Ω for 1A, 3A, 2 Ω for 10 mA 100 mA, 200 Ω for 100 μ A, 1 mA
Input Protection:	Externally accessible 3A, 250 V fuse

Crest Factor and Peak Input

Crest Factor:	For <10:1 errors included. Limited by peak input and 300 kHz bandwidth.
Peak Input:	300% of Range. Limited by maximum input
Overload Ranging	Will select higher range if peak input overload is detected during auto range. Overload is reported in manual ranging.

Settling Considerations

Default delays are selected to give first reading right for most measurements. The input blocking RC time constant must be allowed to fully settle before the most accurate measurements are possible

Frequency and Period Characteristics

Accuracy Specifications (% of reading) ^[1, 3]

Function	Range	Frequency Range	24 Hour ^[2] T _{CAL} C ± 1 °C	90 Day T _{CAL} ± 5 °C	1 Year T _{CAL} ± 5 °C	Temperature Coefficient 0 °C to (T _{CAL} - 5 °C) (T _{CAL} + 5 °C) to 55 °C
Frequency Period	100 mV	3 Hz – 5 Hz	0.07	0.07	0.07	0.005
	to	5 Hz – 10 Hz	0.04	0.04	0.04	0.005
	750 V	10 Hz – 40 Hz	0.02	0.02	0.02	0.001
		40 Hz – 300 kHz	0.005	0.006	0.007	0.001

Additional Errors (% of reading) ^[3]

Frequency	Aperture (resolution / range)			
	1 Second (0.1 ppm)	0.1 Second (1 ppm)	0.01 Second (10 ppm)	0.001 Second (100 ppm)
3 Hz – 5 Hz	0	0.11	0.11	0.11
5 Hz – 10 Hz	0	0.14	0.14	0.14
10 Hz – 40 Hz	0	0.16	0.16	0.16
40 Hz – 300 kHz	0	0.045	0.17	0.17

[1] Specifications are for 90 minute warm-up, using 1 second aperture.

[2] Relative to calibration standards.

[3] For AC input voltages 10% to 120% of range except where noted. 750 V range limited to 750 Vrms. 100 mV range specifications are for full scale or greater inputs. For inputs from 10 mV to 100 mV, multiply total % of reading error by 10.

Transfer Accuracy (typical) 0.0003% of reading

Conditions:

- Within 10 minutes and ± 0.5 °C.
- Within ±10% of initial voltage and ± 1% of initial frequency.
- Following a 2-hour warm-up.
- For inputs > 1 kHz and > 100 mV
- Using 1 second gate time
- Measurements are made using accepted metrology practices.

Frequency and Period

Measurement Type:	Reciprocal-counting technique. AC-coupled input using the AC voltage measurement function.
Input Impedance:	1 M Ω \pm 2%, in parallel with <150 pF
Input Protection:	750 V rms all ranges

Measurement Considerations

All frequency counters are susceptible to error when measuring low-voltage, low-frequency signals. Shielding inputs from external noise pickup is critical for minimizing measurement errors.

Settling Considerations

Errors will occur when attempting to measure the frequency or period of an input following a dc offset voltage change. The input blocking RC time constant must be allowed to fully settle (up to 1 sec.) before the most accurate measurements are possible.

Capacitance Characteristics

Accuracy Specifications (% of reading + % of range)^[1]

Function	Range [2]	Test Current	1 Year $T_{CAL} \pm 5\text{ }^{\circ}\text{C}$	Temperature Coefficient 0 °C to ($T_{CAL} - 5\text{ }^{\circ}\text{C}$) ($T_{CAL} + 5\text{ }^{\circ}\text{C}$) to 55 °C
Capacitance	1 nF	500 nA	0.50 + 0.50	0.05 + 0.05
	10 nF	1 μA	0.40 + 0.10	0.05 + 0.01
	100 nF	10 μA	0.40 + 0.10	0.01 + 0.01
	1 μF	100 μA	0.40 + 0.10	0.01 + 0.01
	10 μF	1 mA	0.40 + 0.10	0.01 + 0.01

[1] Specifications are for 90 minute warm-up using Math Null. Additional errors may occur for non-film capacitors.

[2] Specifications are for 1% to 120% of range on the 1 nF range and 10% to 120% of range on all other ranges.

Capacitance

Measurement Type: Current input with measurement of resulting ramp.

Connection Type: 2 Wire

Temperature Characteristics

Accuracy Specifications^[1]

Function	Probe Type	R_o	Best Range	1 Year $T_{CAL} \pm 5\text{ }^{\circ}\text{C}$	Temperature Coefficient 0 °C to ($T_{CAL} - 5\text{ }^{\circ}\text{C}$) ($T_{CAL} + 5\text{ }^{\circ}\text{C}$) to 55 °C
Temperature	RTD	from 49 W to 2.1 kW	-200 °C to 600 °C	0.06 °C	0.003 °C
	Thermistor	N/A	-80 °C to 150 °C	0.08 °C	0.002 °C

[1] For total measurement accuracy, add temperature *probe error*

Examples (RTD probe, *measurement within "Best Range"*):

1.) *Meter within $T_{CAL} \pm 5\text{ }^{\circ}\text{C}$:* Error = 0.06 °C + *probe error*

2.) *Meter at $T_{CAL} + 10\text{ }^{\circ}\text{C}$:* Error = 0.06 °C + (5 x 0.003 °C) + *probe error* = 0.075 °C + *probe error*

Additional 34411A/L4411A Specifications

Resolution	See table on page 20
Overall Bandwidth, DCV and DCI	15 kHz typical @ 20 μ s aperture (–3 dB)
Triggering	Pre or Post, Internal or External, Positive or Negative
Timebase Resolution	19.9524 μ s, 0.01% accuracy
Trigger Jitter	2 μ s(p-p), 20 μ s(p-p) when pre-triggered
External Trigger Latency	< 3 μ s
Internal Trigger Level Accuracy	1% of range

Spurious-Free Dynamic Range and SNDR

Function	Range	Spurious-Free Dynamic Range	Signal to Noise Distortion Ratio (SNDR)
DCV	100.0000 mV	–55 dB	40 dB
	1.000000 V	–75 dB	60 dB
	10.00000 V ^[1]	–70 dB	65 dB
	100.0000 V	–75 dB	60 dB
	1000.000 V	–60 dB	55 dB
DCI	100.0000 μ A ^[2]	–50 dB	38 dB
	1.000000 mA	–65 dB	50 dB
	10.00000 mA	–45 dB	38 dB
	100.0000 mA	–65 dB	50 dB
	1.000000 A	–65 dB	55 dB
	3.00000 A	–70 dB	55 dB

[1] 10 V range specifications are valid for signals $2 \text{ V(p-p)} < x(t) < 16 \text{ V(p-p)}$

[2] 100 μ A range specifications are valid for signals $28.8 \text{ } \mu\text{A(p-p)} < x(t) < 200 \text{ } \mu\text{A(p-p)}$

Measurement and System Speeds

DMM Measurements Speeds

Function	Resolution (NPLC)	Direct I/O Measurements ^[1] Single Reading – Measure and I/O Time				Measurement Into Memory (Readings/Sec) (VM Complete)
		GPIB Sec	USB 2.0 Sec	LAN (VXI-11) Sec	LAN (Sockets) Sec	
DCV (10 V Range)	0.001 ^[2]	0.0026	0.0029	0.0046	0.0032	50000
	0.006	0.0026	0.0029	0.0046	0.0032	10000
	0.06	0.0031	0.0032	0.0047	0.0040	1000
	1	0.0190	0.0190	0.0200	0.0190	60
ACV (10 V Range)	Slow Filter	0.0100	0.0100	0.0100	0.0100	50
	Medium Filter	0.0100	0.0100	0.0100	0.0100	150
	Fast Filter	0.0100	0.0100	0.0100	0.0100	500
2–Wire Ω (10 kΩ Range)	0.001 ^[2]	0.0026	0.0029	0.0046	0.0032	50000
	0.006	0.0026	0.0029	0.0046	0.0032	10000
	0.06	0.0031	0.0032	0.0047	0.0040	1000
	1	0.0190	0.0190	0.0200	0.0190	60
4–wire Ω (10 kΩ Range)	0.001 ^[2]	0.0054	0.0040	0.0045	0.0056	1500
	0.006	0.0054	0.0040	0.0045	0.0056	1200
	0.06	0.0074	0.0078	0.0078	0.0074	380
	1	0.0390	0.0390	0.0390	0.0390	30
Frequency 1 KHz, 10 V Range Fast Filter	1 ms Gate	0.0100	0.0100	0.0100	0.0100	500
	10 mS Gate	0.0200	0.0200	0.0200	0.0200	80
	100 mS Gate	0.1150	0.1150	0.1130	0.1130	10
	1 S Gate	1.0200	1.0200	1.0200	1.0200	1
Capacitance (100 nF Range)		0.0820	0.0820	0.0820	0.0820	11

[1] Typical. Display off, ½ scale input signal, immediate trigger, trigger delay 0, autozero off, autorange off, no math, 60 Hz line, null off, sample count 1, trig count 1, one interface enabled.

[2] 0.001 PLC applies to 34411A/L4411A only.

Direct I/O Measurements ^[1] (any remote interface)

Sustained maximum reading rate to I/O, 32-bit BINARY data ("SAMP:COUN 50000::R?")

Function	Resolution (NPLC)	rdgs/Sec
DCV	0.001	50000 (34411A/L441A only)
	0.006	10000
ACV	Fast Filter	500
2-Wire Ω	0.001	50000 (34411A/L4411A only)
	0.006	10000
4-Wire Ω	0.001	1500 (34411A/L4411A only)
	0.006	1200
Frequency/Period (1 k rdgs)	1 mS gate, fast filter	450
Capacitance (100 rdgs)		10

[1] ½ scale input signal, immediate trigger, trigger delay 0, autozero off, autorange off, no math, 60 Hz line, null off, sample count 50000, trigger count INF

System Speeds
General

	Configuration ^[1] (Sec)	Auto Range ^[2] (Sec)	Maximum External Trigger Rate ^[3]	Maximum Internal Trigger Rate ^[3]
DCV	0.022	0.0075	5000 / S	10000 / S
ACV	0.037	0.019	500 / S	500 / S
2-Wire Ω	0.022	0.0075	5000 / S	10000 / S
Frequency/Period	0.037	0.019	500 / S	500 / S

[1] Time for configuration change from 2-wire ohms to listed function (or from dc volts to 2-wire ohms) using appropriate FUNCtion command.

[2] Time to automatically change one range and be ready for new measurement, <=10V, <=10Mohm.

[3] Readings to memory.

Range Change

	GPIB ^[1] Sec	USB 2.0 ^[1] Sec	LAN (VXI-11) ^[1] Sec	LAN (Sockets) ^[1] Sec
DCV	0.0026	0.0035	0.0039	0.0039
ACV	0.0064	0.0064	0.0096	0.0065
2-Wire Ω	0.0026	0.0038	0.0039	0.0039
Frequency/Period	0.0064	0.0064	0.0093	0.0065

[1] Time to change from one range to next higher or lower range, <=10V, <=10Mohm.

Data From Memory

Maximum reading rate out of memory

(Sample count 50000, trigger count 1, "FETC?" or "R?")

Readings	GPIB rdg/Sec	USB 2.0 rdg/Sec	LAN (VXI-11) rgs/Sec	LAN (Sockets) rdg/Sec
ASCII	4000	8500	7000	8500
4-byte Binary	89,000	265,000	110,000	270,000
8-byte Binary	47,000	154,000	60,000	160,000

General Specifications (34410A/11A)

Power Supply:	100V/120V/ 220V / 240V ± 10%
Power Line Frequency:	50–60 Hz ± 10%, 400 Hz ± 10%. Automatically sensed at power-on, 400 Hz defaults to 50Hz.
Power Consumption:	34410A/34411A: 25 VA peak (16 W average) L4411A: 50 VA peak (18 W average)
Operating Environment:	Full accuracy for 0 °C to 55 °C Full accuracy to 80% R.H. at 40 °C Non-condensing
Storage Temperature	–40 °C to 70 °C
Operating Altitude	Up to 3000m
Rack Dimensions (WxHxD):	212.8mm x 88.3mm x 272.3mm (34410A/11A)
Bench Dimensions (WxHxD):	261.2mm x 103.8mm x 303.2mm (34410A/11A)
Weight:	3.72 kg (8.2 lbs) 3410A/11A
Safety:	IEC 61010-1 EN 61010-1 UL 61010-1 CAN/CSA-C22.2 No. 61010-1 Refer to Declaration of Conformity for current revisions. Measurement CAT II 300V, CAT I 1000V Pollution Degree 2
EMC:	IEC 61326 EN 61326 CISPR 11 ICES-001 AS/NZS 2064.1 Refer to Declaration of Conformity for current revisions.
Acoustic Noise	37 dBa
Display:	Dual-line, 17-segment vacuum florescent display (34410A/34411A)
State Storage Memory	Power Off state automatically saved, 4 User Configurable Stored States

Remote Interfaces	GPIB IEEE–488, 10/100Mbit LAN, USB 2.0 Standard
Language	SCPI – 1994.0, IEEE–488.2
LXI Compliance	LXI Class C, Version 1.0
Warm–up Time	90 minutes

General Specifications (L4411A)

Power Supply:	Universal 100V to 240V \pm 10%
Power Line Frequency:	45 Hz to 440 Hz \pm 10% automatically sensed Automatically sensed at power–on, 400 Hz defaults to 50Hz.
Power Consumption:	50 VA peak (18 W average)
Operating Environment:	Full accuracy for 0 °C to 55 °C Full accuracy to 80% R.H. at 40 °C Non–condensing
Storage Temperature	–40 °C to 70 °C
Dimensions (HxWxL):	40.9 X 212.3 X 363.2mm 1.61 X 8.36 X 14.3 in
Weight:	1.9 kg (4.25 lbs)
Display:	Dual–line, 5 X 7 dot matrix, 16 character LCD
Safety:	Conforms to CSA, UL/IEC/EN 61010-1
EMC:	Conforms to IEC/EN 61326-1, CISPR 11
Warranty:	1 year

Triggering and Memory

Reading Hold Sensitivity:	1% of reading
Samples per Trigger:	1 to 50,000 (<i>34410A</i>) 1 to 1,000,000 (<i>34411A/L4411A</i>)
Trigger Delay:	0 to 3600 sec (20 μ s step size)
External Trigger	Low–power TTL compatible input programmable edge triggered
Delay:	< 1 μ s
Jitter:	< 1 μ s
Max rate	up to 5 kHz
Min Pulsewidth	1 μ s
Voltmeter Complete	3 V Logic output
Polarity	Programmable edge pulse
Pulsewidth	Approximately 2 μ s
Non–volatile Memory	50,000 reading
Sample Timer	
Range	Up to 3600 sec in 20 μ s steps
Jitter	< 100 ns

1 Specifications

Dimensions

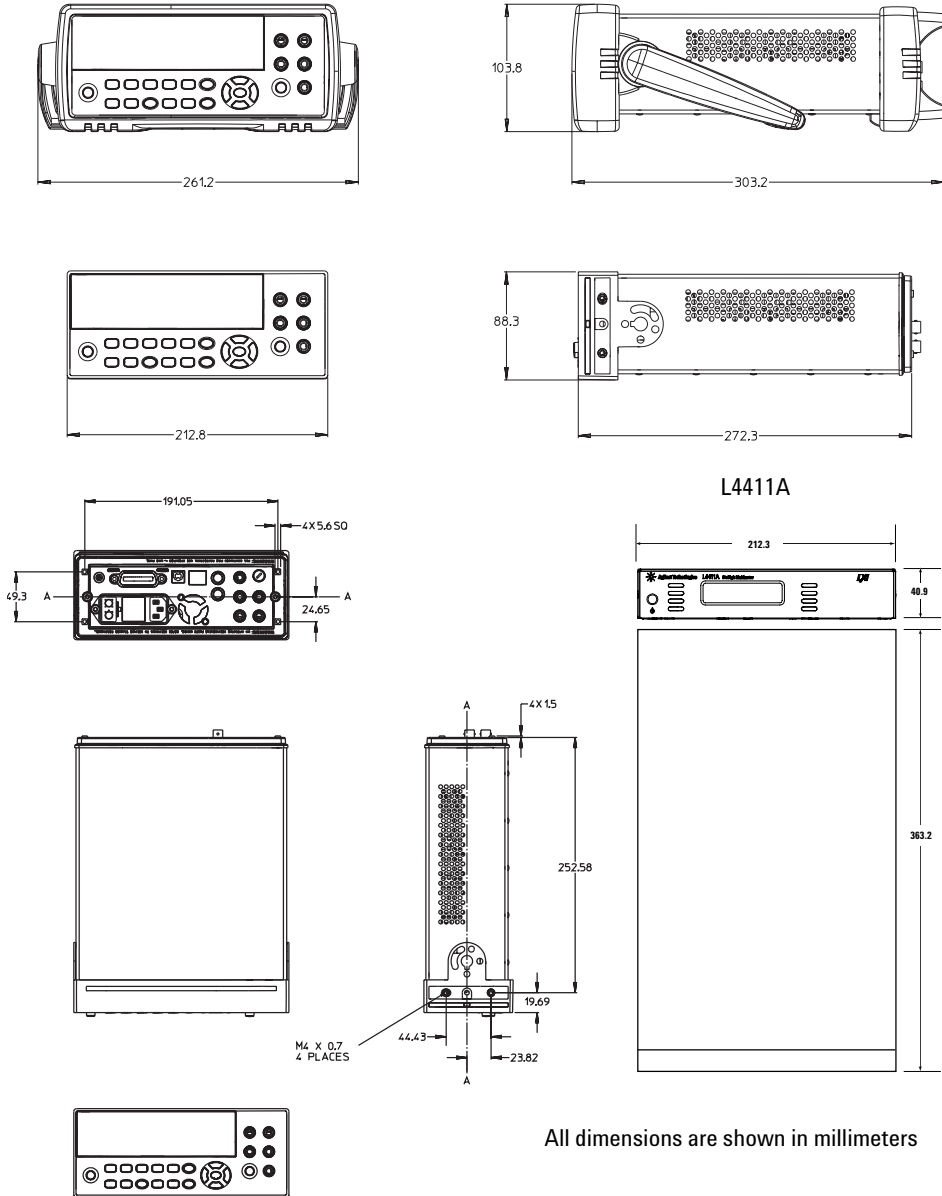

To Calculate Total Measurement Error

The multimeter's accuracy specifications are expressed in the form: (% of reading + % of range). In addition to the reading error and range error, you may need to add additional errors for certain operating conditions. Check the list below to make sure you include all measurement errors for a given function. Also, make sure you apply the conditions as described in the footnotes on the specification pages.

- If you are operating the multimeter outside the temperature range specified, apply an additional temperature coefficient error.
- For dc voltage, dc current, and resistance measurements, you may need to apply an additional reading speed error or autozero OFF error.
- For ac voltage and ac current measurements, you may need to apply an additional low frequency error or crest factor error.

Understanding the " % of reading " Error The reading error compensates for inaccuracies that result from the function and range you select, as well as the input signal level. The reading error varies according to the input level on the selected range. This error is expressed in percent of reading. The following table shows the reading error applied to the multimeter's 24-hour dc voltage specification.

Range	Input Level	Reading Error (% of reading)	Reading Error (Voltage)
10 VDC	10 VDC	0.0015	±150 mV
10 VDC	1 VDC	0.0015	±15 mV
10 VDC	0.1 VDC	0.0015	±1.5 mV

Understanding the " % of range " Error The range error compensates for inaccuracies that result from the function and range you select. The range error contributes a constant error, expressed as a percent of range, independent of the input signal level. The following table shows the range error applied to the multimeter's 24-hour dc voltage specification.

Range	Input Level	Range Error (% of range)	Range Error (Voltage)
10 VDC	10 VDC	0.0004	±40 mV
10 VDC	1 VDC	0.0004	±40 mV
10 VDC	0.1 VDC	0.0004	±40 mV

Total Measurement Error To compute the total measurement error, add the reading error and range error. You can then convert the total measurement error to a "percent of input" error or a "ppm (parts-per-million) of input" error as shown below.

$$\% \text{ of input error} = \frac{\text{Total Measurement Error}}{\text{Input Signal Level}} \times 100$$

$$\text{ppm of input error} = \frac{\text{Total Measurement Error}}{\text{Input Signal Level}} \times 1,000,000$$

Error Example Assume that a 5 VDC signal is input to the multimeter on the 10 V range. Compute the total measurement error using the 90-day accuracy specifications: ± (0.0020% of reading + 0.0005% of range).

$$\text{Reading Error} = 0.0020\% \times 5 \text{ VDC} = 100 \text{ mV}$$

$$\text{Range Error} = 0.0005\% \times 10 \text{ VDC} = 50 \text{ mV}$$

$$\begin{aligned} \text{Total Error} &= 100 \text{ mV} + 50 \text{ mV} &&= 150 \text{ mV} \\ &&&= 0.003\% \text{ of } 5 \text{ VDC} \\ &&&= 30 \text{ ppm of } 5 \text{ VDC} \end{aligned}$$

Interpreting Accuracy Specifications

Transfer Accuracy

Transfer accuracy refers to the error introduced by the multimeter due to noise and short-term drift. This error becomes apparent when comparing two nearly-equal signals for the purpose of "transferring" the known accuracy of one device to the other.

24-Hour Accuracy

The 24-hour accuracy specification indicates the multimeter's relative accuracy over its full measurement range for short time intervals and within a stable environment. Short-term accuracy is usually specified for a 24-hour period and for a ± 1 °C temperature range.

90-Day and 1-Year Accuracy

These long-term accuracy specifications are valid at the calibration temperature (T_{cal}) ± 5 °C temperature range. These specifications include the initial calibration errors plus the multimeter's long-term drift errors.

Temperature Coefficients

Accuracy is usually specified at the calibration temperature (T_{cal}) ± 5 °C temperature range. This is a common temperature range for many operating environments. You must add additional temperature coefficient errors to the accuracy specification if you are operating the multimeter outside the ± 5 °C temperature range (the specification is per °C).

Configuring for Highest Accuracy Measurements

The measurement configurations shown below assume that the multimeter is in its power-on or reset state. It is also assumed that auto-ranging is enabled to ensure proper full scale range selection.

DC Voltage, DC Current, and Resistance Measurements:

- Select NPLC and 100 (NPLCs) for INTEGRATION.
- Set INPUT Z to HI-Z (for the 100 mV, 1 V, and 10 V ranges) for the best dc voltage accuracy.
- Use the 4-wire ohms function (W 4W) for the best resistance measurement accuracy.
- For 2-wire ohms, dc voltage and dc current measurements, set AUTOZERO to ON to remove thermal EMF and offset errors.
- Null the test lead resistance for 2-wire ohms measurements, and to remove any interconnection offset for dc voltage measurements.

AC Voltage and AC Current Measurements:

- Set the AC FILTER to 3 Hz: SLOW.

Frequency and Period Measurements:

- Set the GATE TIME to 1 sec.



2 Quick Start

This chapter gives you a quick overview of the 34410A/11A multimeter's front panel and basic features. The examples will help you become familiar with your meter, its measuring functions, and basic operation.

Basic Multimeter Operations	38
Preparing the Multimeter for Use	38
Using the Front Panel	39
Making Basic Measurements	41
Other Basics of Operation	49
If the Multimeter Does Not Turn On	49
To Replace the Power-Line Fuse (34410A/11A)	50
To Adjust the Carrying Handle (34410A/11A)	51
To Rack Mount the 34410A/11A Multimeter	51
To Rack Mount the L4411A Multimeter	52
Calibration Operation (34410A/11A)	53
To Read the Calibration Count	53
To Read the Calibration Message	54
To Store a Calibration Message	54
To Secure for Calibration	55
To Unsecure for Calibration	56



Basic Multimeter Operations

This section introduces the basics of the 34410A/11A multimeter, and how to use it.

Preparing the Multimeter for Use

To verify that your 34410A or 34411A multimeter is ready for use:

1 Check the list of supplied items.

Verify that you have received the following items with your multimeter. If anything is missing, contact your nearest Agilent Sales Office.

- Test Lead Set (34410A/11A only).
- Power Cord.
- USB 2.0 Cable.
- *Agilent 34410A/11A/L4411A Product Reference* CD-ROM.
- *Agilent Automation Ready* (IO Libraries) CD-ROM.
- *Certificate of Calibration*.

The product documentation, including the *Agilent 34410A/11A/L4411A Programmer's Reference Help* and the product manuals, are included on the *Product Reference* CD-ROM. Printed (hardcopy) manuals are optional, and included only if you ordered them.

2 Connect the power cord and turn on the multimeter.

34410A/11A The front-panel display will light up while the multimeter performs its power-on self-test. The multimeter powers up in the dc voltage function with autoranging enabled (unless a previous user has configured power-up using a non-default stored state (see *Chapter 2, "Features and Functions" in the Agilent 34410A/11A User's Guide*).

L4411A The front-panel display lights up while the multimeter performs its power-on self-test. The display briefly shows the model number and firmware revision code, followed by the instrument MAC address, and finally the readings and LAN status display.

Using the Front Panel

This section introduces the 34410A/11A multimeter front panel.

Front-Panel Keys

The front panel provides keys to select various functions and operations. Pressing a measurement function key (e.g. **DCV**) selects that function. Press **Config** to enter the configuration menu for the selected measurement function.

Most keys have a shifted function printed in blue above the key. To perform a shifted function, press **Shift**, and then press the key that has the desired label above it.



To view and select menu items, use the menu navigation keypad (for example the **Left Arrow** or **Right Arrow** keys). The current (or default) selection is displayed in **FULL BRIGHTNESS**. All other choices are displayed in **HALF BRIGHTNESS**. The selections on each menu level scroll, but do not wrap. Arrow annunciators on the second display line indicate additional selections to the left or right. To accept a selection, press **Enter**.

To set numeric parameters, use **Left Arrow** or **Right Arrow** to select a digit, and **Up Arrow** or **Down Arrow** to increase or decrease that digit.







Front-Panel Display Shortcuts

Direct front-panel shortcuts are provided for three commonly used display functions: ranging, digit masking, and integration time.







Ranging. The multimeter's manual range can be set directly from the navigation keypad.

To manually change the current multimeter range, press  or . The **ManRng** annunciator will light, and the selected range (e.g. 100mV RANGE) will be briefly displayed on the second line.

Digit Masking. The navigation keypad provides a shortcut to mask (change the number of digits displayed) the reading on the main display, easing readability.

To enable digit masking during any measurement function, press   or  . DIGIT MASK will be displayed, along with a list of choices (3.5, 4.5, 5.5, 6.5 and AUTO) on the second display line. Press  or  to scroll through and select one of these settings, and then press .

Integration Time (Bandwidth, Gate Time). Four measurement functions allow you to select the multimeter's integration time: dc voltage, dc current, resistance, and temperature. The ac voltage and current measurements allow you to select the ac signal filter (bandwidth). The frequency/period function allows you to select gate time. The navigation keypad provides a shortcut for quickly changing these settings.

- If the multimeter is configured to take the measurement using an integration time in *NPLCs*, pressing  or  during front panel measurement operations will increase or decrease the integration time setting.
- If either the ac voltage or ac current measurement function is selected, pressing  or  during front panel measurement operations will increase or decrease the bandwidth setting.
- If the frequency/period measurement function is selected, pressing  or  during front panel measurement operations will increase or decrease the gate time setting.

Making Basic Measurements

This section introduces the many types of measurements that you can make with your 34410A/11A multimeter, and how to make connections for each measurement. *Most basic measurements can be taken using the factory default settings.* A more complete description of all multimeter functions, measurement parameter configuration and remote interface operation is provided in Chapter 2.

For each measurement, connect the test leads as shown. The test lead connections are the same for the front or rear set of terminals.

Before making test lead connections, use the **Front/Rear** button on the front panel to select either the front or rear set of terminals. The **Rear** annunciator lights if the rear terminals are selected.

WARNING

Do not press the Front/Rear button while signals are present on either the front or rear set of terminals. Switching while high voltages or currents are present can cause instrument damage, and may increase the risk of electric shock.

To Measure DC Voltage

Press **DCV** to select the dc voltage function.

- Ranges: 100 mV, 1 V, 10 V, 100 V, 1000 V
- Configurable parameters: INTEGRATION, RANGE, INPUT Z (input impedance), AUTO ZERO, NULL, and NULL VALUE

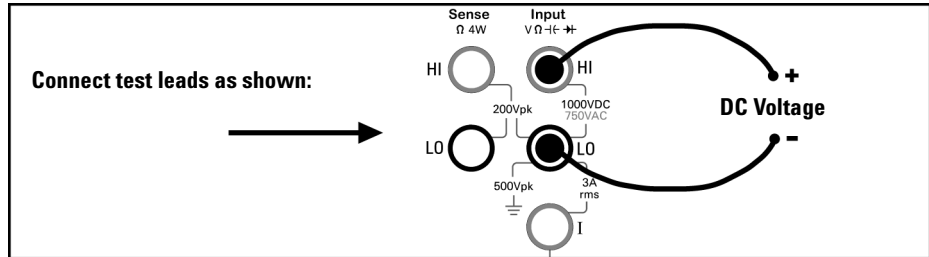

To Measure AC Voltage

Press **ACV** to select the ac voltage function.

- Ranges: 100 mV, 1 V, 10 V, 100 V, 750 V
- AC Technique: true-RMS, ac-coupled
- Configurable parameters: AC FILTER, RANGE, NULL and NULL VALUE

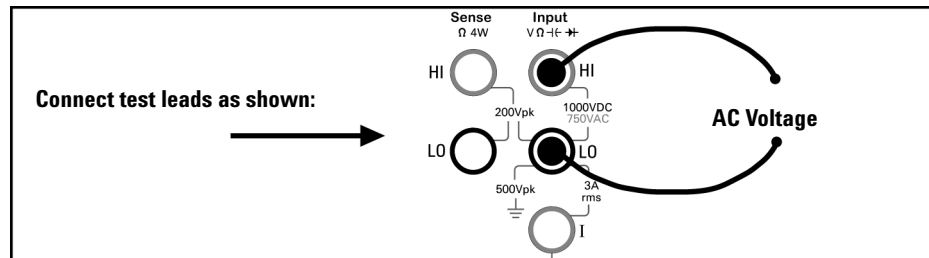

To Measure DC Current

Press **(Shift) (DCV) (DCI)** to select the dc current function.

- Ranges: 100 μ A, 1 mA, 10 mA, 100 mA, 1 A, 3 A
- Configurable parameters: INTEGRATION, RANGE, AUTO ZERO, NULL, and NULL VALUE

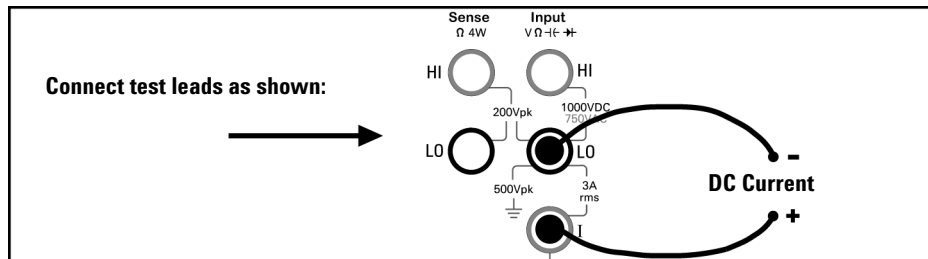

To Measure AC Current

Press **(Shift) (ACV) (ACI)** to select the ac current function.

- Ranges: 100 μ A, 1 mA, 10 mA, 100 mA, 1 A, 3 A
- AC Technique: true-RMS, ac-coupled
- Configurable parameters: AC FILTER, RANGE, NULL and NULL VALUE

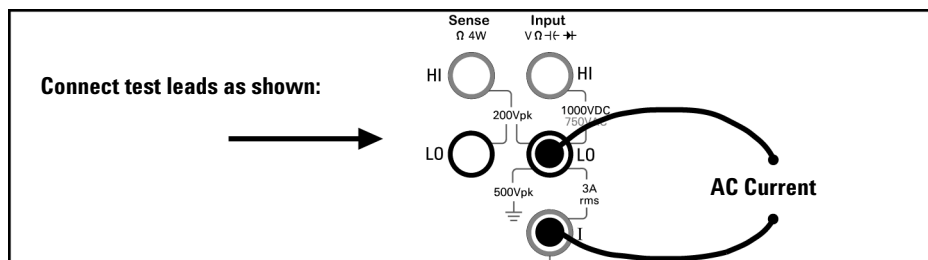

To Make a 2-Wire Resistance Measurement

Press **Ω2W** to select the 2-wire resistance function.

- Ranges: 100 Ω, 1 kΩ, 10 kΩ, 100 kΩ, 1 MΩ, 10 MΩ, 100 MΩ, 1 GΩ
- Configurable parameters: INTEGRATION, RANGE, OFFSET COMP, AUTO ZERO, NULL, and NULL VALUE

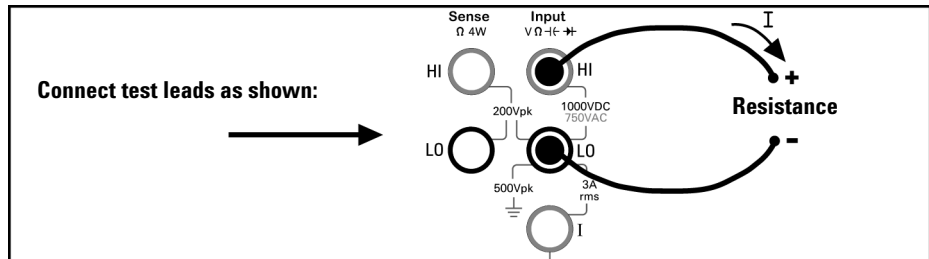

To null-out the test lead resistance:

- 1 Connect one end of the test leads at the meter, and short the probe ends together.
- 2 Press null.
- 3 Connect the probe ends to the test circuit, and measure the corrected resistance value.

To Make a 4-wire Resistance Measurement

Press **Shift** **Ω2W** (**Ω4W**) to select the 4-wire resistance function.

- Ranges: 100 Ω, 1 kΩ, 10 kΩ, 100 kΩ, 1 MΩ, 10 MΩ, 100 MΩ, 1 GΩ
- Configurable parameters: INTEGRATION, RANGE, OFFSET COMP, NULL, and NULL VALUE

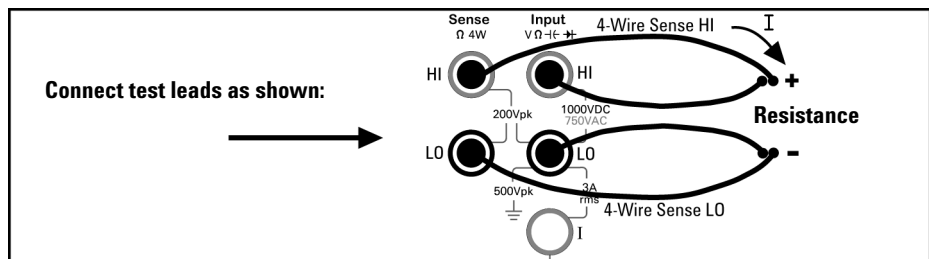

All 4-wire resistance measurements are made with auto-zero on.

To Measure Frequency

Press **Freq** to select the frequency function.

- Measurement band: 3 Hz to 300 kHz
- Input signal range: 100 mVAC to 750 VAC
- Technique: reciprocal counting
- Configurable parameters: GATE TIME, RANGE, AC FILTER, NULL and NULL VALUE

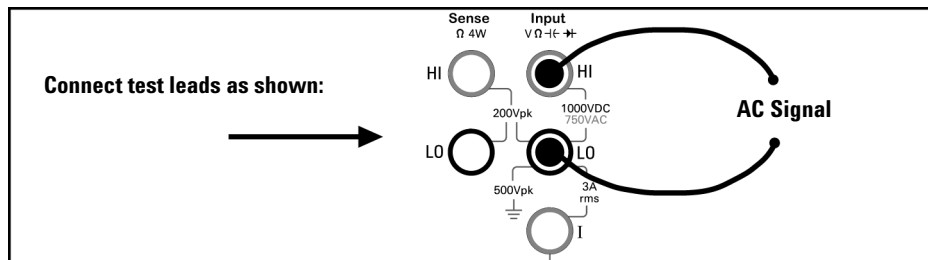

To Measure Period

Press **Freq** to select the frequency function. Then press **Config** and select PERIOD from the menu.

- Measurement band: 0.33 s to 3.3 μ s
- Input signal range: 100 mVAC to 750 VAC
- Technique: reciprocal counting
- Configurable parameters: GATE TIME, RANGE, AC FILTER, NULL and NULL VALUE

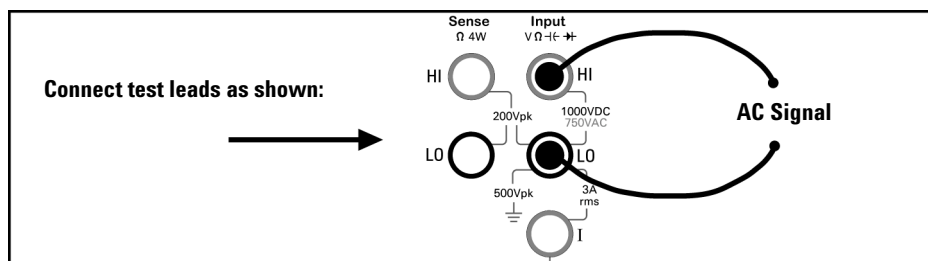

To Measure Capacitance

Press **(Shift)** **(Freq)** (⇧) to select the capacitance function.

- Ranges: 1 nF, 10 nF, 100 nF, 1 μF , 10 μF
- Configurable parameters: RANGE, NULL, and NULL VALUE

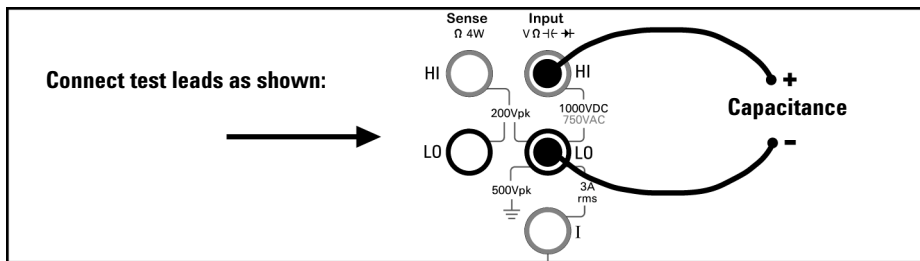

To null-out the test lead capacitance:

- 1 Disconnect the + lead's probe end from the test circuit, and leave open.
- 2 Press null.
- 3 Reconnect the + lead's probe end to the test circuit, and measure the corrected capacitance value.

To Make a 2-Wire Temperature Measurement

Press **(Shift) (Config) (Temp)** to select the temperature function. Then press **(Config)** and select RTD-2W or THERMISTOR-2W from the menu.

- Probe types: 2.2 k Ω , 5 k Ω , 10 k Ω thermistors; 0.00385%/ $^{\circ}\text{C}$ RTD
- Configurable parameters: PROBE TYPE, THERMISTOR or RTD value, AUTO ZERO, OFFSET COMP (*RTD probes only*), INTEGRATION, UNITS, NULL, and NULL VALUE

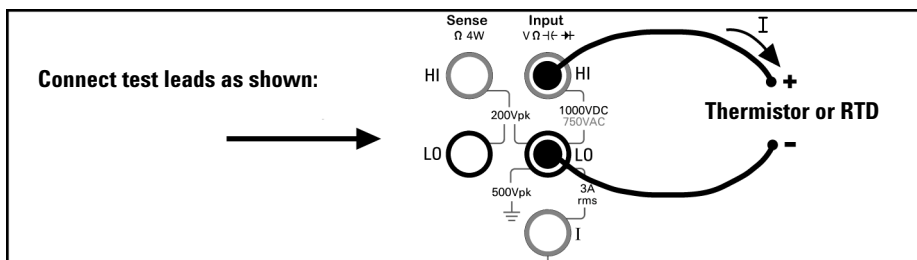

To Make a 4-Wire Temperature Measurement

Press **(Shift) (Config) (Temp)** to select the temperature function. Then press **(Config)** and select RTD-4W or THERMISTOR-4W from the menu.

- Probe types: 2.2 k Ω , 5 k Ω , 10 k Ω thermistors; 0.00385%/ $^{\circ}\text{C}$ RTD
- Configurable parameters: PROBE TYPE, THERMISTOR or RTD value, OFFSET COMP (*RTD probes only*), INTEGRATION, UNITS, NULL, and NULL VALUE

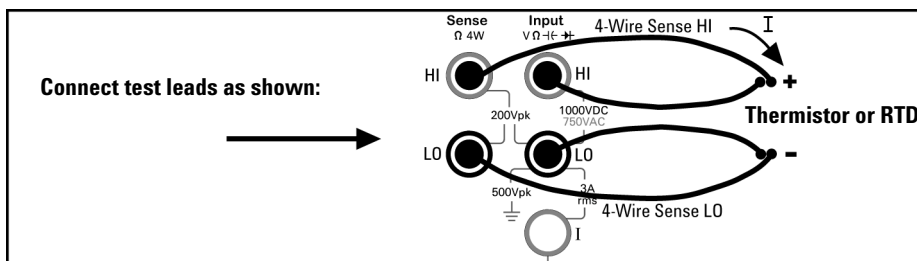

All 4-wire temperature measurements are made with auto-zero on.

To Test Continuity

Press **(Cont)]** to select the continuity function.

- Test current source: 1 mA
- Beeper Threshold: beeps below 10Ω

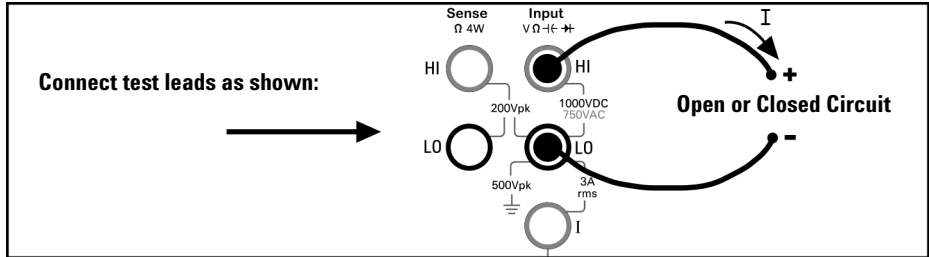

To Check Diodes

Press **(Shift) (Cont)]** (+) to select the diode test function.

- Test current source: 1 mA
- Beeper Threshold: $0.3V \leq \text{voltage}_{\text{measured}} \leq 0.8V$ (*not adjustable*)

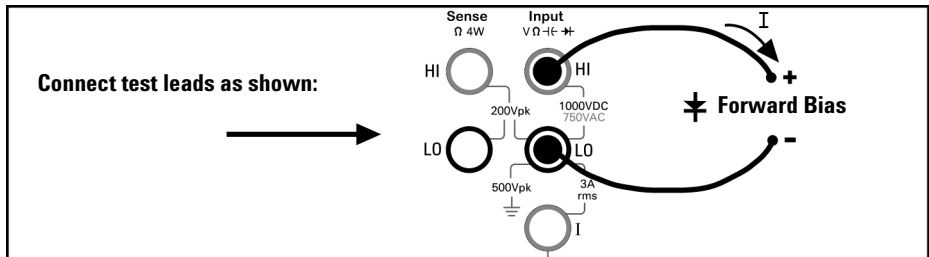

The diode check function is used to indicate correct diode operation; closed-circuit on forward bias and open-circuit on reverse-bias.

Other Basics of Operation

This section covers basic troubleshooting and general use.

If the Multimeter Does Not Turn On

Use the following steps to help solve problems you might encounter when turning on the multimeter. If you need more help, see the *Service Guide* for instructions on returning the multimeter to Agilent for service.

1 Verify that there is ac power to the multimeter.

First, verify that the multimeter's Power switch is in the "On" position. Also, make sure that the power cord is firmly plugged into the power module on the rear panel. You should also make sure that the power source you plugged the multimeter into is energized.

2 Verify the power-line voltage setting (34410A/11A only).

The line voltage is set to the proper value for your country when the multimeter is shipped from the factory. Change the voltage setting if it is not correct. The settings are: 100, 120, 220, or 240 Vac (for 230 Vac operation, use the 220 Vac setting).

See "To Replace the Power-Line Fuse (34410A/11A)" on page 50 if you need to change the line-voltage setting.

3 Verify that the power-line fuse is good (34410A/11A only).

The multimeter is shipped from the factory with a power-line fuse installed. The supplied fuse is a **250 mA, 250V, slow-blow, 5x20mm fuse, Agilent part number 2110-0817**. If you determine that the fuse is faulty, replace it with one of the same size and rating.

See "To Replace the Power-Line Fuse (34410A/11A)" on page 50 if you need to replace the power-line fuse.

The *current input path* is also fused. The supplied fuse is a **3 AT, 250V, slow-blow, 5x20mm fuse, Agilent part number 2110-0780**, and is housed in a standard screw-in fuse holder on the rear panel. If you determine that the fuse is faulty, replace it with one of the same size and rating.

To Replace the Power-Line Fuse (34410A/11A)

Remove power cord first. Then follow these steps:

1 Depress tab (1) and pull fuse holder (2) from rear panel.

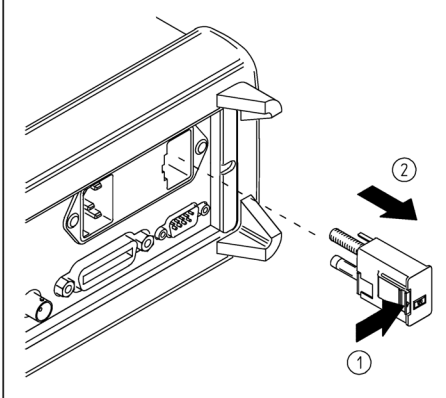

2 Remove line-voltage selector from fuse holder assembly.

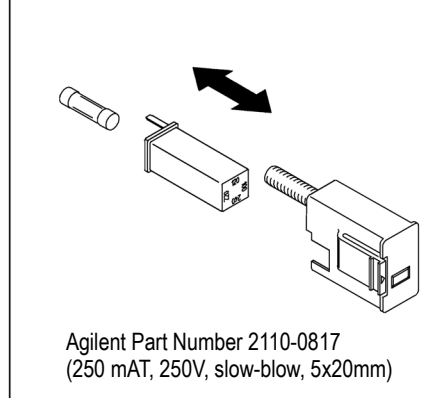

3 Rotate line-voltage selector and reinstall so correct voltage appears in fuse holder window.

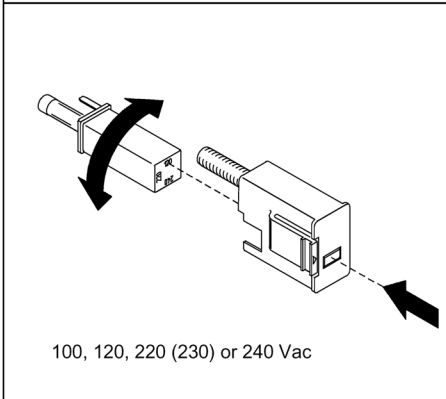

4 Replace fuse holder assembly in rear panel.

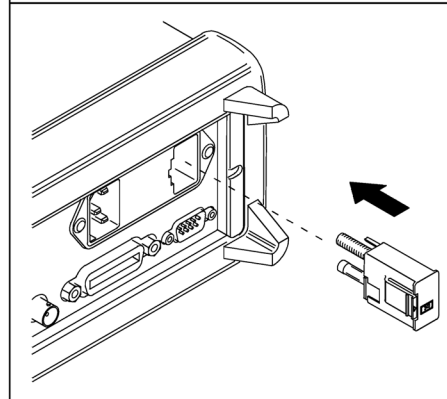

Verify that the correct line voltage is selected and the power-line fuse is good.

NOTE

For multimeter operations with a 230 VAC supply, set the line-voltage selector to 220V.

To Adjust the Carrying Handle (34410A/11A)

To adjust the position, grasp the handle by the sides and *pull outward*. Then, rotate the handle to the desired position.

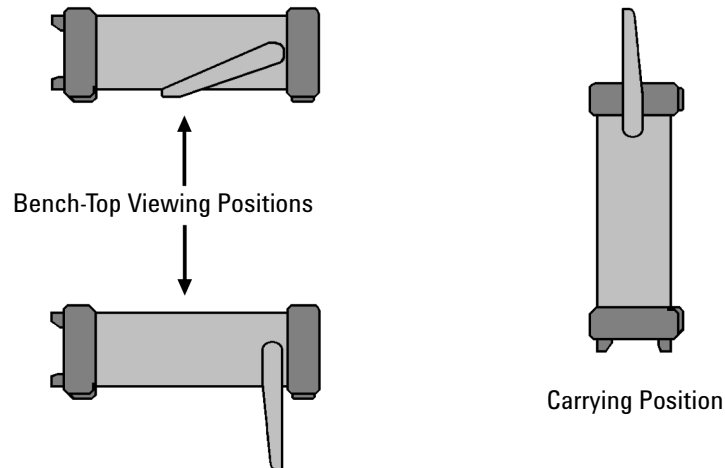

To Rack Mount the 34410A/11A Multimeter

You can mount the 34410A/11A in a standard 19-inch rack cabinet using the available rack-mount kits. Instructions and mounting hardware are included with each kit. Any Agilent System II (half-width, 2U height) instrument of either the 272.3 mm or the 348.3 mm depth can be rack mounted side-by-side with the 34410A/11A. For example, a 34410A/11A and a 34401A, or two 34410A/11As, can be mounted side-by-side, as shown on the next page.

You must remove the carrying handle, and the front and rear rubber bumpers, before rack mounting an instrument.



To remove each bumper, stretch a corner and slide it off.

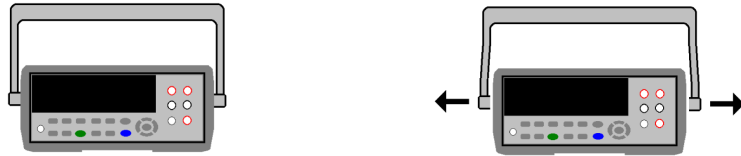

To remove the handle, rotate it to the vertical position and pull the ends outward.

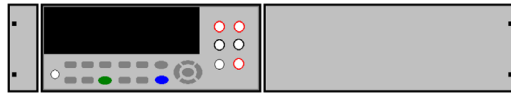

To rack mount a single instrument, order adaptor kit 5063-9240

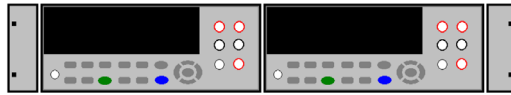

To rack mount two instruments side-by-side, order lock-link kit 5061-8769 and flange kit 5063-9212

To Rack Mount the L4411A Multimeter

The L4411A is mounted in EIA rack cabinets using the Y1160A rack mount kit. The kit allows you to mount one or two L4400 instruments side-by-side on a sliding shelf, while occupying one EIA rack unit of space. Rack mounting instructions are provided with the kit

Calibration Operation (34410A/11A)

From the front panel you can:

- Read the calibration count
- Read and set the calibration message.
- Secure and unsecure the instrument for calibration.

To Read the Calibration Count

You can query the instrument to determine how many calibrations have been performed. Note that your instrument was calibrated before it left the factory. When you receive your instrument, read the count to determine its initial value. The count value increments by one for each calibration point, and a complete calibration will increase the value by many counts.

- 1 Press **Shift** **Data Log** (**Utility**) .
- 2 Select CALIBRATION from UTILITY MENU.
- 3 Select COUNT from CALIBRATION.
- 4 Make note of the CAL COUNT.

To Read the Calibration Message

The instrument allows you to store a message in calibration memory. For example, you can store such information as the date when the last calibration was performed, the date when the next calibration is due, the instrument's serial number, or even the name and phone number of the person to contact for a new calibration.

You can record a calibration message only when the instrument is unsecured. You can read the calibration message whether the instrument is secured or unsecured.

- 1 Press **Shift** **Data Log** (**Utility**) .
- 2 Select CALIBRATION from UTILITY MENU.
- 3 Select MESSAGE from CALIBRATION.

To Store a Calibration Message

You can record a calibration message only when the instrument is unsecured (see “[To Unsecure for Calibration](#)” on page 56).







- 1 Press **Shift** **Data Log** (**Utility**) .
- 2 Select CALIBRATION from UTILITY MENU.
- 3 Select MESSAGE from CALIBRATION.
- 4 Use **←** or **→** to select each character in the message. Change the characters by pressing **▲** or **▼** to cycle through all the possible display characters. The full alphabet is available as well as the digits 0 through 9, spaces, and special characters.
- 5 Press **Enter** when done.

To Secure for Calibration

This feature allows you to enter a security code to prevent accidental or unauthorized adjustments of the instrument. When you first receive your instrument, it is secured. Before you can adjust the instrument, you must unsecure it by entering the correct security code.

The security code is set to AT34410 (AT34411 for the Agilent 34411A) when the instrument is shipped from the factory. The security code is stored in non-volatile memory, and does not change when power has been off, after a Factory Reset (*RST command), or after an Instrument Preset (SYSTEM:PRESet command).

The security code may contain up to 12 alphanumeric characters. The first character must be a letter, but the remaining characters can be letters, numbers, or an underscore (_). You do not have to use all 12 characters but the first character must always be a letter.

- 1 Press   (Utility) .
- 2 Select CALIBRATION from UTILITY MENU.
- 3 Select SECURE from CALIBRATION.
- 4 The currently set security code is shown. Use  or  to select each character in the code. Change the characters by pressing  or  to cycle through all the possible display characters. The full alphabet is available as well as the digits 0 through 9. The first character must be a letter.
- 5 Press  when done.

To Unsecure for Calibration

Before you can adjust the instrument, you must unsecure it by entering the correct security code. The security code is set to AT34410 when the instrument is shipped from the factory. The security code is stored in non-volatile memory, and does not change when power has been off, after a Factory Reset (*RST command), or after an Instrument Preset (SYSTEM:PRESet command).

The security code may contain up to 12 alphanumeric characters. The first character must be a letter, but the remaining characters can be letters, numbers, or an underscore (_). You do not have to use all 12 characters but the first character must always be a letter.

NOTE

If you forget your security code, you can disable the security feature by applying a temporary short inside the instrument as described in [“To Unsecure the Instrument Without the Security Code”](#) on page 75

- 1 Press **Shift** **Data Log** (Utility)
- 2 UTILITY MENU > CALIBRATION > UNSECURE > ENTER CODE
- 3 Use **Left Arrow** or **Right Arrow** to set each character in the code. Change the characters by pressing **Up Arrow** or **Down Arrow** to cycle through all the possible display characters. The full alphabet is available as well as the digits 0 through 9. The first character must be a letter.
- 4 Press **Enter** when done. The CAL UNSECURED message appears briefly.

To Re-secure

To re-secure the multimeter after a calibration, reverse the process:

Press **Shift** **Data Log** (Utility)

UTILITY MENU > CALIBRATION > SECURE > SET CAL CODE

The previous calibration code is proposed. Press **Enter** to accept that code, or use the navigation keypad to enter a new code. The CAL SECURED message appears briefly when you press the **Enter** key.

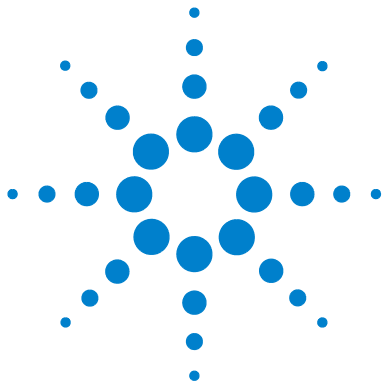

3 Calibration Procedures

Agilent Technologies Calibration Services	58
Calibration Interval	58
Adjustment is Recommended	58
Time Required for Calibration	59
Automating Calibration Procedures	59
Recommended Test Equipment	60
Performance Verification Tests	60
Input Connections	62
Test Considerations	63
Verification Tests	64
Calibration Security	75
Calibration Message	77
Calibration Count	77
Calibration Process	78
Aborting a Calibration in Progress	79
Adjustments	80

This manual contains procedures for verification of the instrument's performance and adjustment (calibration).

Closed-Case Electronic Calibration. The instrument features closed-case electronic calibration. No internal mechanical adjustments are required. The instrument calculates correction factors based upon the input reference value you set. The new correction factors are stored in non-volatile memory until the next calibration adjustment is performed. Non-volatile EEPROM calibration memory does not change when power has been off or after a remote interface reset.



Agilent Technologies Calibration Services

Agilent Technologies offers calibration services at competitive prices. When your instrument is due for calibration, contact your local Agilent Service Center for recalibration. See “[Types of Service Available](#)” on page 105 for information on contacting Agilent.

Calibration Interval

The instrument should be calibrated on a regular interval determined by the measurement accuracy requirements of your application.

A 1-year interval is adequate for most applications. Accuracy specifications will remain valid only if adjustment is made at regular calibration intervals. Accuracy specifications are not valid beyond the 1-year calibration interval. Agilent does not recommend extending calibration intervals beyond 2 years for any application.

Adjustment is Recommended

Specifications are only valid within the period stated from the last adjustment. Whatever calibration interval you select, Agilent recommends that complete re-adjustment always be performed at the calibration interval. This is necessary to ensure that the instrument will remain within specification for the next calibration interval. This criteria for re-adjustment provides the best long-term stability.

Performance data measured during Performance Verification Tests does not mean that the instrument will remain within these limits unless the adjustments are performed.

Use the Calibration Count feature (see [page 77](#)) to verify that all adjustments have been performed.

Time Required for Calibration

The instrument can be automatically calibrated under computer control. With computer control you can perform the complete calibration procedure and performance verification tests in less than 30 minutes once the instrument is warmed-up (see Test Considerations on [page 63](#)).

Automating Calibration Procedures

The adjustment procedures provided in this Service Guide demonstrate front panel adjustment. You can automate the complete verification and adjustment procedures outlined in this manual. You can program the instrument configurations specified for each test over the remote interface. You can then enter read back verification data into a test program and compare the results to the appropriate test limit values.

The instrument must be unsecured prior to initiating the calibration procedure (see “Calibration Security” on [page 75](#)).

Refer to the *Agilent 34410A/11A/L4411A Programmer's Reference Help* for information on SCPI programming for the multimeter. This is a standard Windows online help system, provided with the multimeter on the *Agilent 34410A/11A/L4411A Product Reference CD-ROM*. It is also downloadable from the Web. See either product page:

www.agilent.com/find/34410A

www.agilent.com/find/34411A

www.agilent.com/find/L4411A

Recommended Test Equipment

The test equipment recommended for the performance verification and adjustment procedures is listed below. If the exact instrument is not available, substitute calibration standards of equivalent accuracy.

A suggested alternate method would be to use the Agilent 3458A 8½-digit Digital Multimeter to measure less accurate yet stable sources. The output value measured from the source can be entered into the instrument as the target calibration value.

Application	Recommended Equipment	Accuracy Requirements
Zero Calibration	Agilent 34172B (2 recommended)*	4 –terminal low thermal short
DC Voltage	Fluke 5720A	<1/5 instrument 24 hour spec
DC Current	Fluke 5720A	<1/5 instrument 24 hour spec
Resistance	Fluke 5720A	<1/5 instrument 24 hour spec
AC Voltage	Fluke 5720A	<1/5 instrument 24 hour spec
AC Current	Fluke 5720A	<1/5 instrument 24 hour spec
Frequency	Agilent 33220A	<1/5 instrument 24 hour spec
Capacitance	IET SCA–1µF	<1/5 instrument 24 hour spec

* Only one 34172B is required for the L4411A.

Performance Verification Tests

Use the Performance Verification Tests to verify the measurement performance of the instrument. The performance verification tests use the instrument's specifications listed in the Product Data Sheet.

You can perform four different levels of performance verification tests:

- **Self-Test.** A series of internal verification tests that give a high confidence that the instrument is operational.
- **Quick Verification.** A combination of the internal self-tests and selected verification tests.
- **Performance Verification Tests.** An extensive set of tests that are recommended as an acceptance test when you first receive the instrument or after performing adjustments.
- **Additional Verification Tests.** Tests not performed with every calibration. Perform these tests to verify additional specifications or functions of the instrument.

Self-Test

A brief power-on self-test occurs automatically whenever you turn on the instrument. This limited test assures that the instrument is capable of operation.

- During the self-test all display segments and annunciators are lit.
- **34410A/11A** If the self-test fails, the **ERROR** annunciator turns on. Read any errors using the front panel Utility menu (select SCPI ERRORS), or use the `SYSTEM:ERROR?` command query from the remote interface.
- **L4411A** If the self-test fails, an error message will appear in the display. Use the `SYSTEM:ERROR?` command query from the remote interface.

If repair is required, contact an Agilent Service Center.

- If all tests pass, you have a high confidence (~90%) that the instrument is operational.
- You can initiate a more complete self test by sending the `*TST?` command to the instrument. This command returns a “+0” if all the self-tests pass, or a “+1” if a failure occurred. This command may take up to 30 seconds to complete. You may need to set an appropriate interface time-out value.

Quick Performance Check

The quick performance check is a combination of internal self-test and an abbreviated performance test (specified by the letter **Q** in the performance verification tests). This test provides a simple method to achieve high confidence in the instrument’s ability to functionally operate and meet specifications. These tests represent the absolute minimum set of performance checks recommended following any service activity. Auditing the instrument’s performance for the quick check points (designated by a **Q**) verifies performance for “normal” accuracy drift mechanisms. This test does not check for abnormal component failures.

To perform the quick performance check, do the following:

- Perform a self-test as described on [page 61](#).
- Perform only the performance verification tests indicated with the letter **Q**.

If the instrument fails the quick performance check, adjustment or repair is required.

Performance Verification Tests

The performance verification tests are recommended as acceptance tests when you first receive the instrument. The acceptance test results should be compared against the 90 day test limits. You should use the 24-hour test limits only for verification within 24 hours after performing the adjustment procedure. After acceptance, you should repeat the performance verification tests at every calibration interval.

If the instrument fails performance verification, adjustment or repair is required.

Adjustment is recommended at every calibration interval. If adjustment is not made, you must establish a 'guard band', using no more than 80% of the specifications, as the verification limits.

Input Connections

Test connections to the instrument are best accomplished using an Agilent Technologies 34172B calibration short for low-thermal offset measurements and a 34171B DMM connector configured to interface to the calibrator output. Shielded, twisted-pair, Teflon interconnect cables of minimum length are recommended between the calibrator and the multimeter. HI and HI Sense should be a twisted pair. LO and LO Sense should be a twisted pair. Cable shields should be earth ground referenced. This configuration is recommended for noise reduction and settling time performance during calibration.

Test Considerations

Errors may be induced by ac signals present on the input leads during a self-test. Long test leads can also act as an antenna causing pick-up of ac signals.

For optimum performance, all procedures should comply with the following recommendations:

- Assure that the calibration ambient temperature (T_{cal}) is stable and between 18 °C and 28 °C. Ideally the calibration should be performed at 23 °C \pm 2 °C.
- Assure ambient relative humidity is less than 80%.
- Allow a 90 minute warm-up period with a copper short connected.
- Use shielded twisted pair Teflon-insulated cables to reduce settling and noise errors. Keep the input cables as short as possible.
- Connect the input cable shields to earth ground. Except where noted in the procedures, connect the calibrator LO source to earth ground at the calibrator. It is important that the LO to earth ground connection be made at only *one* place in the circuit to avoid ground loops.

Because the instrument is capable of making highly accurate measurements, you must take special care to ensure that the calibration standards and test procedures used do not introduce additional errors. Ideally, the standards used to verify and adjust the instrument should be an order of magnitude more accurate than each instrument range full scale error specification.

For the dc voltage, dc current, and resistance gain verification measurements, you should take care to ensure the calibrator's "0" output is correct. You will need to set the offset for each range of the measuring function being verified.

Verification Tests

Zero Offset Verification

This procedure is used to check the zero offset performance of the instrument. Verification checks are only performed for those functions and ranges with unique offset calibration constants. Measurements are checked for each function and range as described in the procedure on the next page.

Zero Offset Verification Procedure (34410A/11A)

- 1 Make sure you have read “[Test Considerations](#)” on page 63.
- 2 Install the 34172B Calibration Short (or equivalent) on the front panel input terminals. Select the **Front** input terminals with the **Front/Rear** switch.
- 3 Select each function and range in the order shown in the table below. Make a measurement and return the result. Compare measurement results to the appropriate test limits shown in the table on the next page.
- 4 Install the 34172B Calibration Short (or equivalent) on the rear panel input terminals. Select the **Rear** input terminals with the **Front/Rear** switch.
- 5 Select each function and range in the order shown in the table below. Make a measurement and return the result. Compare measurement results to the appropriate test limits shown in the table below.

Zero Offset Verification Procedure (L4411A only)

- 1 Make sure you have read “[Test Considerations](#)” on page 63.
- 2 Install the 34172B Calibration Short (or equivalent) on the input terminals.
- 3 Select each function and range in the order shown in the table below. Make a measurement and return the result. Compare measurement results to the appropriate test limits shown in the table on the next page.

Input	Function ^[1]	Range	Quick Check	Error from Nominal		
				24 hour	90 day	1 year
Open	DC Current	100 μ A		$\pm 0.02 \mu$ A	$\pm 0.025 \mu$ A	$\pm 0.025 \mu$ A
Open		1 mA		$\pm 0.060 \mu$ A	$\pm 0.060 \mu$ A	$\pm 0.060 \mu$ A
Open		10 mA		$\pm 2 \mu$ A	$\pm 2 \mu$ A	$\pm 2 \mu$ A
Open		100 mA	Q	$\pm 4 \mu$ A	$\pm 5 \mu$ A	$\pm 5 \mu$ A
Open		1 A		$\pm 60 \mu$ A	$\pm 100 \mu$ A	$\pm 100 \mu$ A
Open		3 A		$\pm 600 \mu$ A	$\pm 600 \mu$ A	$\pm 600 \mu$ A
Short	DC Volts	100 mV	Q	$\pm 3 \mu$ V	$\pm 3.5 \mu$ V	$\pm 3.5 \mu$ V
Short		1 V		$\pm 6 \mu$ V	$\pm 7 \mu$ V	$\pm 7 \mu$ V
Short		10 V		$\pm 40 \mu$ V	$\pm 50 \mu$ V	$\pm 50 \mu$ V
Short		100 V		$\pm 600 \mu$ V	$\pm 600 \mu$ V	$\pm 600 \mu$ V
Short		1000 V		± 6 mV	± 6 mV	± 6 mV
Short	4–Wire Ohms ^[2]	100 Ω		± 3 m Ω	± 4 m Ω	± 4 m Ω
Short		1 k Ω		± 5 m Ω	± 10 m Ω	± 10 m Ω
Short		10 k Ω	Q	± 50 m Ω	± 100 m Ω	± 100 m Ω
Short		100 k Ω		± 500 m Ω	± 1 Ω	± 1 Ω
Short		1 M Ω		± 10 Ω	± 10 Ω	± 10 Ω
Short		10 M Ω		± 100 Ω	± 100 Ω	± 100 Ω
Short		100 M Ω		± 1 k Ω	± 1 k Ω	± 1 k Ω

[1] Select 100 NPLC.

[2] Specifications are for 4–wire Ohms function or 2–wire Ohms function using math null. Without math null, add 0.2 Ω additional error in the 2–wire Ohm function.

Q: Quick performance verification test points.

Gain Verification

This procedure is used to check the “full scale” reading accuracy of the instrument. Verification checks are performed only for those functions and ranges with unique gain calibration constants.

DC Volts Gain Verification Test

- 1 Make sure you have read “Test Considerations” on page 63.
- 2 Connect the calibrator to the input terminals.
 - a For the 34410A/11A use the front panel input terminals and select the **Front** input terminals with the **Front/Rear** switch.
- 3 Select each function and range in the order shown below. Provide the input shown in the table below.
- 4 Make a measurement and return the result. Compare measurement results to the appropriate test limits shown in the table. (Be certain to allow for appropriate source settling when using the Fluke 5720A.)

Input		Range	Quick Check	Error from Nominal		
Voltage	Function ^[1]			24 hour	90 day	1 year
100 mV	DC Volts	100 mV		± 6 µV	± 7.5 µV	± 8.5 µV
-100 mV		100 mV		± 6 µV	± 7.5 µV	± 8.5 µV
1 V		1 V		± 26 µV	± 37 µV	± 42 µV
10 V		10 V	Q	± 190 µV	± 250 µV	± 350 µV
-10 V		10 V		± 190 µV	± 250 µV	± 350 µV
100 V		100 V	Q	± 2.6 mV	± 4.1 mV	± 4.6 mV
1000 V		1000 V		± 26 mV	± 41 mV	± 46 mV

[1] Select 100 NPLC.

Q: Quick performance verification test points.

DC Current Gain Verification Test

- 1 Make sure you have read “[Test Considerations](#)” on page 63
- 2 Connect the calibrator to the input terminals.
 - a For the 34410A/11A use the front panel input terminals and select the **Front** input terminals with the **Front/Rear** switch.
- 3 Select each function and range in the order shown below. Provide the input shown in the table below.
- 4 Make a measurement and return the result. Compare measurement results to the appropriate test limits shown in the table. (Be certain to allow for appropriate source settling when using the Fluke 5720A.)

Input		Range	Quick Check	Error from Nominal		
Current	Function ^[1]			24 hour	90 day	1 year
100 μ A	DC Current	100 μ A		$\pm 0.03 \mu$ A	$\pm 0.065 \mu$ A	$\pm 0.075 \mu$ A
1 mA		1 mA		$\pm 0.13 \mu$ A	$\pm 0.36 \mu$ A	$\pm 0.56 \mu$ A
10 mA		10 mA	Q	$\pm 2.7 \mu$ A	$\pm 5 \mu$ A	$\pm 7 \mu$ A
100 mA		100 mA		$\pm 14 \mu$ A	$\pm 35 \mu$ A	$\pm 55 \mu$ A
1 A		1 A	Q	$\pm 560 \mu$ A	$\pm 900 \mu$ A	± 1.1 mA
2 A		3 A		± 2.6 mA	± 3 mA	± 3.6 mA

[1] Select 100 NPLC.

Q: Quick performance verification test points.

Ohms Gain Verification Test

Configuration: 4-Wire Ohms (CONFigure:FRESistance)

- 1 Make sure you have read “Test Considerations” on page 63.
- 2 Set the 4-Wire Ohms function.
- 3 Connect the calibrator to the input terminals.
 - a For the 34410A/11A use the front panel input terminals and select the **Front** input terminals with the **Front/Rear** switch.
- 4 Select each range in the order shown below. Provide the resistance value indicated. Compare measurement results to the appropriate test limits shown in the table. (Be certain to allow for appropriate source settling.)

Input Resistance	Function ^[1]	Range	Quick Check	Error from Nominal		
				24 hour	90 day	1 year
100 Ω	4-Wire Ohms	100 Ω		± 6 mΩ	± 12 mΩ	± 14 mΩ
1 kΩ		1 kΩ	Q	± 25 mΩ	± 80 mΩ	± 110 mΩ
10 kΩ		10 kΩ		± 250 mΩ	± 800 mΩ	± 1.1 Ω
100 kΩ		100 kΩ		± 2.5 Ω	± 8 Ω	± 11 Ω
1 MΩ		1 MΩ		± 30 Ω	± 110 Ω	± 130 Ω
10 MΩ		10 MΩ	Q	± 1.1 kΩ	± 3.1 kΩ	± 4.1 kΩ
100 MΩ ^[2]		100 MΩ		± 201 kΩ	± 601 kΩ	± 801 kΩ

[1] Select 100 NPLC.

[2] Verify only, no adjustment. 2-Wire Ohms.

Q: Quick performance verification test points.

Frequency Gain Verification Test

Configuration: Frequency (CONFIGure:FREQuency DEF, MIN)

- 1 Make sure you have read “Test Considerations” on page 63.
- 2 Select the Frequency function, default range, and minimum resolution (1 second aperture).
- 3 Connect the Agilent 33220A to the input terminals.
 - a For the 34410A/11A use the front panel input terminals and select the **Front** input terminals with the **Front/Rear** switch.
- 4 Select each range in the order shown below. Provide the input voltage and frequency indicated. Compare measurement results to the appropriate test limits shown in the table. (Be certain to allow for appropriate source settling.)

Input		Range	Quick Check	Error from Nominal		
Vrms	Frequency			24 hour	90 day	1 year
10 mV	40 Hz	100 mV		± 20 mHz	± 24 mHz	± 28 mHz
10 V	10 kHz	10 V	Q	± 0.5 Hz	± 0.6 Hz	± 0.7 Hz

Q: Quick performance verification test points.

AC Volts Verification Test

Configuration: AC Volts (CONFIGure[:VOLTage]:AC)
 LF 3 HZ:SLOW ([SENSe:]VOLTage:AC:BANDwidth 3)

- 1 Make sure you have read “Test Considerations” on page 63.
- 2 Connect the calibrator to the input terminals.
 - a For the 34410A/11A use the front panel input terminals and select the **Front** input terminals with the **Front/Rear** switch.
- 3 Set the AC Volts function and the 3 Hz input filter. With the slow filter selected, each measurement takes 2.5 seconds to complete.
- 4 Select each range in the order shown below. Provide the indicated input voltage and frequency. Compare measurement results to the appropriate test limits shown in the table. (Be certain to allow for appropriate source settling.)

Input			Quick	Error from Nominal		
Vrms	Frequency	Range	Check	24 hour	90 day	1 year
100 mV	1 kHz	100 mV		± 40 µV	± 80 µV	± 90 µV
100 mV	50 kHz	100 mV	Q	± 90 µV	± 140 µV	± 150 µV
100 mV	300 kHz	100 mV		± 1.50 mV	± 1.70 mV	± 1.70 mV
1 V	1 kHz	1 V		± 400 µV	± 800 µV	± 900 µV
1 V	50 kHz	1 V		± 900 µV	± 1.4 mV	± 1.5 mV
1 V	300 kHz	1 V		± 15 mV	± 17 mV	± 17 mV
10 V	10 Hz	10 V		± 4.03 mV	± 8.03 mV	± 9.03 mV
10 V	1 kHz	10 V		± 4 mV	± 8 mV	± 9 mV
10 V	50 kHz	10 V	Q	± 9 mV	± 14 mV	± 15 mV
10 V	300 kHz	10 V		± 150 mV	± 170 mV	± 170 mV
100 V	1 kHz	100 V	Q	± 40 mV	± 80 mV	± 90 mV
100 V	50 kHz	100 V		± 90 mV	± 140 mV	± 150 mV
50 V	300 kHz	100 V		± 1 V	± 1.1 V	± 1.1 V
750 V	1 kHz	750 V		± 615 mV	± 915 mV	± 990 mV
210 V	50 kHz	750 V		± 405 mV	± 564 mV	± 585 mV
70 V	300 kHz	750 V		± 4.45 V	± 4.59 V	± 4.59 V

Q: Quick performance verification test points.

AC Current Verification Test

Configuration: AC Current (CONFigure:CURRENT:AC)
 LF 3 HZ:SLOW ([SENSE:]CURRENT:AC:BANDwidth 3)

- 1 Make sure you have read “Test Considerations” on page 63.
- 2 Connect the calibrator to the input terminals.
 - a For the 34410A/11A use the front panel input terminals and select the **Front** input terminals with the **Front/Rear** switch.
- 3 Set the AC Current function and the 3 Hz input filter. With the slow filter selected, each measurement takes 1.7 seconds to complete.
- 4 Select each range in the order shown below. Provide the input current and frequency indicated. Compare measurement results to the appropriate test limits shown in the table. (Be certain to allow for appropriate source settling.)

Input		Range	Quick Check	Error from Nominal		
Current, rms	Frequency			24 hour	90 day	1 year
100 μ A	1 kHz	100 μ A		$\pm 0.14 \mu$ A	$\pm 0.14 \mu$ A	$\pm 0.14 \mu$ A
100 μ A	5 kHz	100 μ A	Q	$\pm 0.14 \mu$ A	$\pm 0.14 \mu$ A	$\pm 0.14 \mu$ A
1 mA	1 kHz	1 mA		$\pm 1.4 \mu$ A	$\pm 1.4 \mu$ A	$\pm 1.4 \mu$ A
1 mA	5 kHz	1 mA		$\pm 1.4 \mu$ A	$\pm 1.4 \mu$ A	$\pm 1.4 \mu$ A
10 mA	1 kHz	10 mA		$\pm 14 \mu$ A	$\pm 14 \mu$ A	$\pm 14 \mu$ A
10 mA	10 kHz	10 mA		$\pm 24 \mu$ A	$\pm 24 \mu$ A	$\pm 24 \mu$ A
100 mA	1 kHz	100 mA		$\pm 140 \mu$ A	$\pm 140 \mu$ A	$\pm 140 \mu$ A
100 mA	10 kHz	100 mA		$\pm 240 \mu$ A	$\pm 240 \mu$ A	$\pm 240 \mu$ A
1 A	1 kHz	1 A		± 1.4 mA	± 1.4 mA	± 1.4 mA
1 A	5 kHz	1 A		± 1.4 mA	± 1.4 mA	± 1.4 mA
2 A	1 kHz	3 A		± 4.8 mA	± 4.8 mA	± 4.8 mA
2 A	5 kHz	3 A		± 4.8 mA	± 4.8 mA	± 4.8 mA

Q: Quick performance verification test points.

Additional AC Voltage Performance Verification Tests

Configuration: AC Volts (CONFigure[:VOLTage]:AC)
 LF 3 HZ:SLOW ([SENSe:]VOLTage:AC:BANDwidth 3)

- 1 Make sure you have read “Test Considerations” on page 63.
- 2 Connect the calibrator to the input terminals.
 - a For the 34410A/11A use the front panel input terminals and select the **Front** input terminals with the **Front/Rear** switch.
- 3 Set the AC Volts function and the 3 Hz input filter. With the slow filter selected, each measurement takes 2.5 seconds to complete.
- 4 Select each range in the order shown below. Provide the indicated input voltage and frequency. Compare measurement results to the appropriate test limits shown in the table. (Be certain to allow for appropriate source settling.)

Input			Error from Nominal		
Vrms	Frequency	Range	24 hour	90 day	1 year
1 V	10 Hz	1 V	± 430 µV	± 830 µV	± 930 µV
1 V	1 kHz	1 V	± 400 µV	± 800 µV	± 900 µV
1 V	20 kHz	1 V	± 400 µV	± 800 µV	± 900 µV
1 V	50 kHz	1 V	± 900 µV	± 1.4 mV	± 1.5 mV
1 V	100 kHz	1 V	± 2.8 mV	± 3.8 mV	± 4.8 mV
1 V	300 kHz	1 V	± 15 mV	± 17 mV	± 17 mV
10 V	1 kHz	10 V	± 4 mV	± 8 mV	± 9 mV
1 V	1 kHz	10 V	± 2.2 mV	± 3.5 mV	± 3.6 mV
0.1 V	1 kHz	10 V	± 2.02 mV	± 3.05 mV	± 3.06 mV

Additional AC Current Performance Verification Tests

Configuration: AC Current (CONFigure:CURRENT:AC)
 LF 3 HZ:SLOW ([SENSE:]CURRENT:AC:BANDwidth 3)

- 1 Make sure you have read “Test Considerations” on page 63
- 2 Connect the calibrator to the input terminals.
 - a For the 34410A/11A use the front panel input terminals and select the **Front** input terminals with the **Front/Rear** switch.
- 3 Set the AC Current function and the 3 Hz input filter. With the slow filter selected, each measurement takes 2.5 seconds to complete.
- 4 Select each range in the order shown below. Provide the indicated input voltage and frequency. Compare measurement results to the appropriate test limits shown in the table. (Be certain to allow for appropriate source settling.)

Input			Error from Nominal		
Current, rms	Frequency	Range	24 hour	90 day	1 year
1 mA	10 Hz	1 mA	± 1.4 µA	± 1.4 µA	± 1.4 µA
1 mA	1 kHz	1 mA	± 1.4 µA	± 1.4 µA	± 1.4 µA
1 mA	5 kHz	1 mA	± 1.4 µA	± 1.4 µA	± 1.4 µA
1 mA	10 kHz	1 mA	± 2.4 µA	± 2.4 µA	± 2.4 µA
100 mA	1 kHz	100 mA	± 140 µA	± 140 µA	± 140 µA
10 mA	1 kHz	100 mA	± 50 µA	± 50 µA	± 50 µA
1 mA	1 kHz	100 mA	± 41 µA	± 41 µA	± 41 µA

Additional Capacitance Performance Verification Tests

Configuration: Capacitance

CONFigure:CAPacitance

- 1 Make sure you have read “[Test Considerations](#)” on page 63.
- 2 Set the Capacitance function.
- 3 Connect the calibrator to the input terminals.
 - a For the 34410A/11A use the front panel input terminals and select the **Front** input terminals with the **Front/Rear** switch.
- 4 Select each range in the order shown below. Provide the indicated input. Compare measurement results to the appropriate test limits shown in the table. (Be certain to allow for appropriate source settling.)

Input		Error from Nominal
Capacitance	Range	1 year
1 μ F	1 μ F	$\pm 0.005 \mu$ F
1 μ F	10 μ F	$\pm 0.014 \mu$ F

Calibration Security

This feature allows you to enter a security code to prevent accidental or unauthorized adjustments of the instrument. When you first receive your instrument, it is secured. Before you can adjust the instrument, you must unsecure it by entering the correct security code.

See [“To Unsecure for Calibration”](#) on page 56 for a procedure to enter the security code from the front panel. Use the `CAL:SEC:STAT ON` command to enter the security code using the remote interface.

NOTE

If you forget your security code, you can disable the security feature by following the procedure below.

- The security code is set to AT34410, AT34411, or ATL4411 when the instrument is shipped from the factory (depending on the model). The security code is stored in non-volatile memory, and does not change when power has been off, after a Factory Reset (`*RST` command), or after an Instrument Preset (`SYSTEM:PRESet` command).
- The security code may contain up to up to 12 characters. You do not have to use all 12 characters but the first character must always be a letter (A-Z). The remaining 11 characters can be letters, numbers (0-9), or the underscore character (“_”). Blank spaces are not allowed

To Unsecure the Instrument Without the Security Code

To unsecure the instrument without the correct security code, follow the steps below. See [“To Unsecure for Calibration”](#) on page 56. See [“Electrostatic Discharge \(ESD\) Precautions”](#) on page 110 before beginning this procedure.

NOTE

If you do not have a record of the security code, try the factory default code (**AT34410**, **AT34411**, or **ATL4411** depending on model) before you use the procedure below.

3 Calibration Procedures

- 1 Disconnect the power cord and all input connections.
- 2 Disassemble the instrument using the “[General Disassembly](#)” on page 111.
- 3 Solder a temporary short between the two exposed metal pads on the main PC board assembly. The general location is shown in the figure below. On the 34410/11A PC board, the pads are marked **JM101**. On the L4411A the pads are marked **UNSEC**.

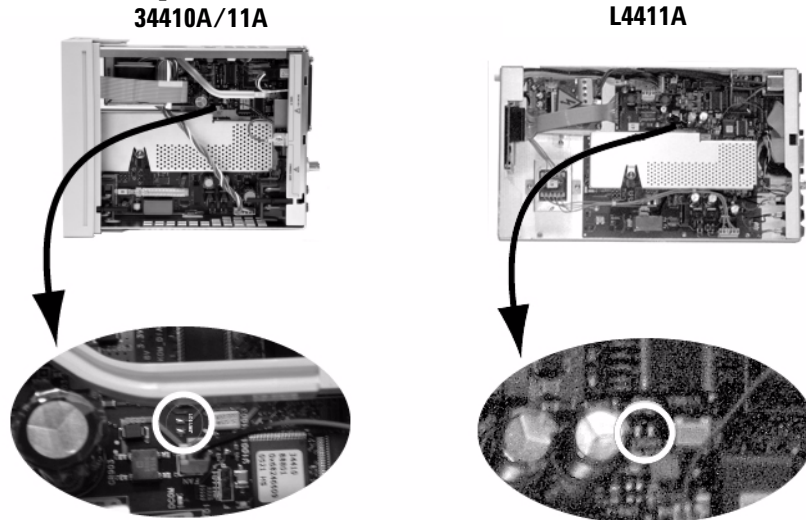

- 4 Apply power and turn on the instrument.

WARNING

Be careful not to touch the power line connections or high voltages on the power input module and transformer. Power is present even if the instrument is turned off when the line cord is connected.

- 5 The display will show the message “Calibration security has been disabled”. The instrument is now unsecured.
- 6 Turn off the instrument and remove the power cord.
- 7 Remove the temporary short installed in step 3.
- 8 Reassemble the instrument.

Now you can enter a new security code, see “[To Secure for Calibration](#)” on page 55. Be sure you record the new security code.

Calibration Message

The instrument allows you to store a message in calibration memory. For example, you can store such information as the date when the last calibration was performed, the date when the next calibration is due, the instrument's serial number, or even the name and phone number of the person to contact for a new calibration. The calibration message may contain up to 40 characters.

You can record a calibration message only when the instrument is unsecured. You can read the calibration message whether the instrument is secured or unsecured.

See [“To Read the Calibration Message”](#) on page 54 and [“To Store a Calibration Message”](#) on page 54. Use the `CALibration:STRING` and `CALibration:STRING?` commands from the remote interface.

Calibration Count

You can query the instrument to determine how many calibrations have been performed. Note that your instrument was calibrated before it left the factory. When you receive your instrument, be sure to read the count to determine its initial value.

The calibration count increments up to a maximum of 2^{32} (over 4 billion) after which it rolls over to “0”. Since the value increments by one for each calibration point, a complete calibration may increase the value by many counts.

See [“To Read the Calibration Count”](#) on page 53. Use the `CALibration:COUNT?` command from the remote interface.

Calibration Process

The following general procedure is the recommended method to complete a full instrument calibration.

- 1 Read “[Test Considerations](#)” on page 63.
- 2 Perform the verification tests to characterize the instrument (incoming data).
- 3 Unsecure the instrument for calibration (“[Calibration Security](#)” on page 75).
- 4 Perform the adjustment procedures (“[Adjustments](#)” on page 80).
- 5 Secure the instrument against calibration.
- 6 Note the new security code and calibration count in the instrument’s maintenance records.

Using the Front Panel for Adjustments (34410A/11A Only)

This is the general process used to perform adjustments from the front panel. Refer to the *34410A/11A Programmer’s Reference Help* for remote interface commands.





Selecting the Adjustment Mode

Press   (Utility)

UTILITY MENU > CALIBRATION > CALIBRATE

Select ADC or DMM.

Entering Adjustment Values

To enter a calibration value from the front panel, use  or  to select the digit in the displayed value, and use  or  to cycle through 0 - 9 for each digit. Press  when done.

Storing the Calibration Constants

Press   (Utility)

UTILITY MENU > CALIBRATION > CALIBRATE > STORE

This stores the constants in non-volatile memory.

Using the Remote Interface for Adjustments

All adjustments can be made using the remote interface. You must use the remote interface for the L4411A. Commands used to perform the adjustments are listed in CALibration subsystem of the *34410A/11A/L4411A Programmer's Reference*.

Selecting the Adjustment Mode

Use the CALibration:ADC? query to begin the ADC calibration. The response to this query indicates a successful adjustment (0) or a failure (1). Following the ADC calibration, use the measurement commands to set the DMM measurement parameters and functions for the mode being calibrated.

Entering Adjustment Values

To enter a calibration value from the remote interface use the CALibration:VALue <value> command followed by the CALibration? query. The response to the query indicates whether the adjustment is valid.

Storing the Calibration Constants

To store the calibration values in non-volatile memory, use the CALibration:STORe command.

Aborting a Calibration in Progress

Sometimes it may be necessary to abort a calibration after the procedure has already been initiated. You can abort a calibration at any time on any module by turning off the power. You can abort a calibration by issuing a remote interface device clear message.

CAUTION

If you abort a calibration in progress when the instrument is attempting to write new calibration constants to EEPROM, you may lose all calibration constants for the function. Typically, upon re-applying power, the instrument will report error **705 Cal:Aborted**. You may also generate errors 740 through 746. If this occurs, you should not use the instrument until a complete re-adjustment has been performed. A list of the possible calibration errors is given on [page 109](#).

Adjustments

You will need a test input cable and connectors set and a low thermal input short, Agilent 34172B (two are recommended for the 34410A/11A), to adjust the instrument (see “[Input Connections](#)” on page 62).

ADC and Zero Adjustment

Each time you perform a zero adjustment, the instrument stores a new set of offset correction constants for every measurement function and range. The instrument will sequence through all required functions and ranges automatically and store new zero offset calibration constants. All offset corrections are determined automatically. You may not correct a single range or function without re-entering ALL zero offset correction constants automatically. This feature is intended to save calibration time and improve zero calibration consistency.

NOTE

Never turn off the instrument during Zero Adjustment. This may cause ALL calibration memory to be lost.

ADC and Zero Adjustment Procedure. Be sure to allow the instrument to warm up and stabilize for 90 minutes before performing the adjustments.

- 1 Follow the steps outlined below. Review “[Test Considerations](#)” on page 63 before beginning this test.
- 2 This procedure will use a low-thermal shorting block installed on the input connectors. Leave the Current input connections open.

NOTE

Two shorting blocks are recommended for the 34410A/11A; one installed on the front panel input connectors and one on the rear panel input connectors. A single shorting block can be used with the 34410A/11A, but care should be exercised to minimize thermal offsets associated with temperature differentials between the shorting block and measurement terminals when changing the block between the front and rear panel.

Adjust the ADC

- 3 **34410A/11A:** Select the front panel input terminals. If using a single shorting block, install the block on the front panel input terminals.
L4411A: Install the shorting block on the input terminals.
- 4 Select the ADC adjustment mode (see [“Selecting the Adjustment Mode”](#) on page 78 or, for the remote interface [page 79](#)).
- 5 The display will show the ADC calibration steps as they progress. The ADC adjustment requires approximately 2 minutes to complete. When finished, the display will show CAL SUCCEEDED.

Zero Adjustment

- 6 Select the DMM adjustment mode (see [“Selecting the Adjustment Mode”](#) on page 78). Enter a calibration value of +0.000 E+0 (see [“Entering Adjustment Values”](#) on page 78).
- 7 The display will show the functions and offset as the adjustments progress. The Zero Adjustment requires approximately 1.5 minutes to complete. When finished, the display will show CAL SUCCEEDED.
34410A/11A: Perform the Rear Terminals Zero Adjustment at step 8.
L4411A: skip to step 10.

Rear Terminals Zero Adjustment (34410A/11A Only)

- 8 Select the rear input terminals. If using a single shorting block, install the block on the rear panel input terminals.
- 9 Repeat steps 6 and 7 for the rear input terminals.

Store The Calibration Constants

- 10 Store the new ADC and Zero adjustment constants (see [“Storing the Calibration Constants”](#) on page 78).
- 11 Perform the [“Zero Offset Verification”](#) on page 64 to check zero calibration results.

Gain Adjustments

The instrument calculates and stores gain corrections for each input value. The gain constant is computed from the calibration value entered for the calibration command and from measurements made automatically during the adjustment procedure.

Most measuring functions and ranges have gain adjustment procedures. The 100 M Ω and 1 G Ω ranges do not have gain calibration procedures.

Adjustments for each function should be performed **ONLY** in the order shown.

Gain Adjustment Considerations

- The ADC and zero adjustment procedure must have been recently performed prior to beginning any gain adjustment procedures.
- Gain adjustments for the 34410A/11A can be made using either the front or rear input terminals. Make sure the **Front/Rear** input selection switch matches the terminals in use.

NOTE

Never turn off the instrument during a Gain Adjustment. This may cause calibration memory for the present function to be lost.

Valid Gain and Flatness Adjustment Input Values. Gain adjustment can be accomplished using the following input values.

Function	Range	Valid Amplitude Input Values
DC Volts	100 mV to 100 V 1000 V	0.9 to 1.1 x Full Scale 450 V to 550 V
DC Current	100 μ A to 1 A 3 A	0.9 to 1.1 x Full Scale 1.8 A to 2.2 A
Ohms 2W, Ohms 4W	100 Ω to 10 M Ω	0.9 to 1.1 x Full Scale
Frequency	Any	Input > 100 mV rms, 990 Hz to 110 kHz
AC Current (rms) ^[1]	100 μ A to 1 A 3 A	0.9 to 1.1 x Full Scale 1.8 A to 2.2 A
AC Volts (rms) ^[1]	100 mV to 100 V ^[2] 750 V	0.9 to 1.1 x Full Scale 189 V to 219 V ^[3]

[1] Valid frequencies are nominal frequencies $\pm 1\%$.

[2] 100 Vac flatness adjustment performed at 50 V $\pm 10\%$.

[3] Actual limit is 300 Vac, but results degrade above 219 Vac.

DC Voltage Gain Calibration Procedure

Review the “[Test Considerations](#)” on page 63 and “[Gain Adjustment Considerations](#)” on page 82 sections before beginning this procedure.

Configuration: DC Voltage

- 1 Configure each function and range shown in the adjustment table below.
- 2 Apply the input signal shown in the “Input” column of the table.

NOTE

Always complete tests in the specified order as shown in the appropriate table.

- 3 Enter the actual applied input voltage (see “[Entering Adjustment Values](#)” on page 78).
 - a Successful completion of each adjustment value is indicated by the message CAL SUCCEEDED flashing in the display.
 - b If a problem is encountered, the display will flash the message CAL FAILED. Check the input value, range, function, and entered adjustment value to correct the problem and repeat the adjustment step.
- 4 Repeat steps 1 through 3 for each gain adjustment point shown in the table.
- 5 Store the new calibration constants (“[Storing the Calibration Constants](#)” on page 78).
- 6 Verify the DC Voltage Gain adjustments using the verification procedures beginning on [page 66](#).

NOTE

Each range in the gain adjustment procedure takes less than 2 seconds to complete.

Input Voltage	Instrument Settings	
	Function	Range
100 mV	DC Volts	100 mV
-100 mV		100 mV
1 V		1 V
10 V		10 V
-10 V		10 V
100 V		100 V
500 V		1000 V

DC Current Gain Calibration Procedure

Review the “[Test Considerations](#)” on page 63 and “[Gain Adjustment Considerations](#)” on page 82 sections before beginning this procedure.

Configuration: DC Current

- 1 Configure each function and range shown in the adjustment table below.
- 2 Apply the input signal shown in the “Input” column of the table.

NOTE

Always complete tests in the specified order as shown in the appropriate table.

- 3 Enter the actual applied input current (see “[Entering Adjustment Values](#)” on page 78).
 - a Successful completion of each adjustment value is indicated by the message CAL SUCCEEDED flashing in the display.
 - b If a problem is encountered, the display will flash the message CAL FAILED. Check the input value, range, function, and entered adjustment value to correct the problem and repeat the adjustment step.
- 4 Repeat steps 1 through 3 for each gain adjustment point shown in the table.
- 5 Store the new calibration constants (“[Storing the Calibration Constants](#)” on page 78).
- 6 Verify the DC Current Gain adjustments using the verification procedures beginning on [page 67](#).

NOTE

Each range in the gain adjustment procedure takes less than 3 seconds to complete.

Input Current	Instrument Settings	
	Function	Range
100 μ A	DC Current	100 μ A
1 mA		1 mA
10 mA		10 mA
100 mA		100 mA
1 A		1 A
2 A		3 A

AC Voltage Gain Calibration Procedure

Review the “[Test Considerations](#)” on page 63 and “[Gain Adjustment Considerations](#)” on page 82 sections before beginning this procedure.

Configuration: AC Voltage

- 1 Configure each function and range shown in the adjustment table below.
- 2 Apply the input signal shown in the “Input” column of the table.

NOTE

Always complete tests in the specified order as shown in the appropriate table.

- 3 Enter the actual applied rms input voltage (see “[Entering Adjustment Values](#)” on page 78).
 - a Successful completion of each adjustment value is indicated by the message CAL SUCCEEDED flashing in the display.
 - b If a problem is encountered, the display will flash the message CAL FAILED. Check the input value, range, function, and entered adjustment value to correct the problem and repeat the adjustment step.
- 4 Repeat steps 1 through 3 for each gain adjustment point shown in the table.
- 5 Store the new calibration constants (“[Storing the Calibration Constants](#)” on page 78).

3 Calibration Procedures

- 6 Verify the AC Voltage Gain adjustments using the verification procedures beginning on [page 70](#).

NOTE

Each range in the gain adjustment procedure takes less than 6 seconds to complete.

Input		Instrument Settings	
Vrms	Frequency	Function	Range
100 mV	1 kHz	AC Volts	100 mV
1 V	1 kHz		1 V
10 V	1 kHz		10 V
100 V	1 kHz		100 V
210 V	1 kHz		750 V

AC Current Gain Calibration Procedure

Review the “[Test Considerations](#)” on page 63 and “[Gain Adjustment Considerations](#)” on page 82 sections before beginning this procedure.

Configuration: AC Current

- 1 Configure each function and range shown in the adjustment table below.
- 2 Apply the input signal shown in the “Input” column of the table.

NOTE

Always complete tests in the specified order as shown in the appropriate table.

- 3 Enter the actual applied rms input current (see “[Entering Adjustment Values](#)” on page 78).
 - a Successful completion of each adjustment value is indicated by the message CAL SUCCEEDED flashing in the display.
 - b If a problem is encountered, the display will flash the message CAL FAILED. Check the input value, range, function, and entered

adjustment value to correct the problem and repeat the adjustment step.

- 4 Repeat steps 1 through 3 for each gain adjustment point shown in the table.
- 5 Store the new calibration constants (“[Storing the Calibration Constants](#)” on page 78).
- 6 Verify the AC Current Gain adjustments using the verification procedures beginning on [page 71](#).

NOTE

Each range in the gain adjustment procedure takes less than 7 seconds to complete.

Input		Instrument Settings	
Current, rms	Frequency	Function	Range
100 μ A	1 kHz	AC Current	100 μ A
1 mA	1 kHz		1 mA
10 mA	1 kHz		10 mA
100 mA	1 kHz		100 mA
1 A	1 kHz		1 A
2 A	1 kHz		3 A

Ohms Gain Calibration Procedure

Review the “[Test Considerations](#)” on page 63 and “[Gain Adjustment Considerations](#)” on page 82 sections before beginning this procedure.

Configuration: 4–Wire Ohms

This procedure adjusts the gain for both the 4–wire and 2–wire Ohms functions, and the offset compensated Ohms function. The 100 M Ω and 1 G Ω range gains are derived from the 10 M Ω range and do not have separate adjustment points.

- 1 Configure each function and range shown in the adjustment table below.
- 2 Apply the input signal shown in the “Input” column of the table.

NOTE

Always complete tests in the specified order as shown in the appropriate table.

- 3 Enter the actual applied input resistance (see “[Entering Adjustment Values](#)” on page 78).
 - a Successful completion of each adjustment value is indicated by the message CAL SUCCEEDED flashing in the display.
 - b If a problem is encountered, the display will flash the message CAL FAILED. Check the input value, range, function, and entered adjustment value to correct the problem and repeat the adjustment step.
- 4 Repeat steps 1 through 3 for each gain adjustment point shown in the table.
- 5 Store the new calibration constants (“[Storing the Calibration Constants](#)” on page 78).
- 6 Verify the Ohms Gain adjustments using the verification procedures beginning on [page 68](#).

NOTE

Each range in the gain adjustment procedure takes less than 10 seconds to complete.

Input	Instrument Settings	
Resistance	Function	Range
100 Ω	4-Wire Ohms	100 Ω
1 k Ω		1 k Ω
10 k Ω		10 k Ω
100 k Ω		100 k Ω
1 M Ω		1 M Ω
10 M Ω		10 M Ω

Frequency Gain Calibration Procedure

Review the “[Test Considerations](#)” on page 63 and “[Gain Adjustment Considerations](#)” on page 82 sections before beginning this procedure.

Configuration: Frequency 10 V range

The frequency accuracy of the Fluke 5720A is insufficient to calibrate the DMM. Its frequency output needs to be calibrated against a more accurate reference. The Agilent 33220A is recommended for this adjustment.

- 1 Configure the function and range shown in the adjustment table below.
- 2 Apply the input signal shown in the “Input” column of the table.
- 3 Enter the actual applied input frequency (see “[Entering Adjustment Values](#)” on page 78).
 - a Successful completion of each adjustment value is indicated by the message CAL SUCCEEDED flashing in the display.
 - b If a problem is encountered, the display will flash the message CAL FAILED. Check the input value, range, function, and entered adjustment value to correct the problem and repeat the adjustment step.
- 4 Store the new calibration constants (“[Storing the Calibration Constants](#)” on page 78).
- 5 Verify the Frequency Gain adjustments using the verification procedures beginning on [page 69](#).

NOTE

Frequency adjustment procedure takes less than 2 seconds to complete.

Input		Instrument
Vrms	Frequency	Range
10 V	10 kHz	10 V

Flatness Adjustments

The instrument stores new flatness correction constants each time this procedure is followed. Flatness constants adjust the DMM for AC Volts and AC current measurements across the usable input frequency band. The flatness constant is computed from the calibration value entered for the calibration command and from measurements made automatically during the adjustment procedure.

Adjustments for each ranges and frequency should be performed **ONLY** in the order shown.

Flatness Adjustment Considerations

- The ADC and zero adjustment procedure must have been recently performed prior to beginning any gain adjustment procedures.
- Flatness adjustments can be made using either the front or the rear input terminals. Make sure the **Front/Rear** selection switch matches the terminals being used.

NOTE

Never turn off the instrument during a Flatness Adjustment. This may cause calibration memory for the present function to be lost.

Valid Flatness Adjustment Input Values

Refer to the table on page [page 83](#).

AC Voltage Low Frequency Flatness Calibration Procedure

Review the “[Test Considerations](#)” on page 63 and “[Flatness Adjustment Considerations](#)” on page 93 sections before beginning this procedure.

Configuration: AC Voltage – 10 V range

- 1 Configure each function and range shown in the adjustment table below.
- 2 Apply the input signal shown in the “Input” column of the table.

NOTE

Always complete tests in the specified order as shown in the appropriate table.

- 3 Enter the actual applied input voltage amplitude (see “[Entering Adjustment Values](#)” on page 78).
 - a Successful completion of each adjustment value is indicated by the message CAL SUCCEEDED flashing in the display.
 - b If a problem is encountered, the display will flash the message CAL FAILED. Check the input value, range, function, and entered adjustment value to correct the problem and repeat the adjustment step.
- 4 Repeat steps 1 through 3 for each flatness adjustment point shown in the table.
- 5 Store the new calibration constants (“[Storing the Calibration Constants](#)” on page 78).
- 6 Verify the AC Low Frequency Flatness adjustments using the verification procedures beginning on [page 70](#).

NOTE

Each voltage and frequency in the flatness adjustment procedure takes less than 7 seconds to complete.

Input		Instrument
Vrms	Frequency	Range
7 V	10 Hz	10 V
7 V	40 Hz	10 V

AC Voltage Flatness Calibration Procedure

Review the “[Test Considerations](#)” on page 63 and “[Flatness Adjustment Considerations](#)” on page 93 sections before beginning this procedure.

Configuration: AC Voltage

The 100V AC range is adjusted with 50Vac input. All AC adjustments uses the 3 Hz bandwidth measurement filter

- 1 Configure each function and range shown in the adjustment table below.
- 2 Apply the input signal shown in the “Input” column of the table.

NOTE

Always complete tests in the specified order as shown in the appropriate table.

- 3 Enter the actual applied voltage input amplitude (see “[Entering Adjustment Values](#)” on page 78).
 - a Successful completion of each adjustment value is indicated by the message CAL SUCCEEDED flashing in the display.
 - b If a problem is encountered, the display will flash the message CAL FAILED. Check the input value, range, function, and entered adjustment value to correct the problem and repeat the adjustment step.
- 4 Repeat steps 1 through 3 for each flatness adjustment point shown in the table.
- 5 Repeat steps 1 through 4 for each input voltage range table 100 mV, 1 V, 10 V, and 100 V.
- 6 Store the new calibration constants (“[Storing the Calibration Constants](#)” on page 78).
- 7 Verify the AC Flatness adjustments using the verification procedures beginning on [page 70](#).

NOTE

Each range in the flatness adjustment procedure takes less than 10 seconds to complete.

3 Calibration Procedures

	Input	Instrument	
	Vrms	Frequency	Range
100 mV		1 kHz	100 mV
		5 kHz	
		10 kHz	
		20 kHz	
		35 kHz	
		50 kHz	
		75 kHz	
		100 kHz	
		200 kHz	
		300 kHz	
		390 kHz	
		400 kHz	
		220 Hz	

	Input		Instrument
	Vrms	Frequency	Range
1 V		1 kHz	1 V
		5 kHz	
		10 kHz	
		20 kHz	
		35 kHz	
		50 kHz	
		75 kHz	
		100 kHz	
		200 kHz	
		300 kHz	
		390 kHz	
		400 kHz	
		220 Hz	

3 Calibration Procedures

	Input		Instrument
	Vrms	Frequency	Range
10 V	1 kHz	10 V	
	5 kHz		
	10 kHz		
	20 kHz		
	35 kHz		
	50 kHz		
	75 kHz		
	100 kHz		
	200 kHz		
	300 kHz		
	390 kHz		
	400 kHz		
	220 Hz		

	Input		Instrument
	Vrms	Frequency	Range
50 V	1 kHz	100 V	
	5 kHz		
	10 kHz		
	20 kHz		
	35 kHz		
	50 kHz		
	75 kHz		
	100 kHz		
	200 kHz		
	300 kHz		
	390 kHz		
	400 kHz		
	220 Hz		

AC Current Flatness Calibration Procedure

Review the “[Test Considerations](#)” on page 63 and “[Flatness Adjustment Considerations](#)” on page 93 sections before beginning this procedure.

Configuration: AC Current

All AC adjustments use the 3 Hz bandwidth measurement filter

- 1 Configure each function and range shown in the adjustment table below.
- 2 Apply the input signal shown in the “Input” column of the table.

NOTE

Always complete tests in the specified order as shown in the appropriate table.

- 3 Enter the actual applied input current amplitude (see “[Entering Adjustment Values](#)” on page 78).
 - a Successful completion of each adjustment value is indicated by the message CAL SUCCEEDED flashing in the display.
 - b If a problem is encountered, the display will flash the message CAL FAILED. Check the input value, range, function, and entered adjustment value to correct the problem and repeat the adjustment step.
- 4 Repeat steps 1 through 3 for each flatness adjustment point shown in the table.
- 5 Repeat steps 1 through 4 for each input voltage range table 100 μ A, 1 mA, 10 mA, 100 mA and 1 A.
- 6 Store the new calibration constants (“[Storing the Calibration Constants](#)” on page 78).
- 7 Verify the AC Current Flatness adjustments using the verification procedures beginning on [page 71](#).

NOTE

Each current and frequency in the flatness adjustment procedure takes less than 10 seconds to complete.

Input		
Current, rms	Frequency	Range
100 μ A	1 kHz	100 μ A
	5 kHz	
	7.5 kHz	
	9.7 kHz	
	10 kHz	
	220 Hz	
	220 Hz	
1 mA	1 kHz	1 mA
	5 kHz	
	7.5 kHz	
	9.7 kHz	
	10 kHz	
	220 Hz	
	220 Hz	
10 mA	1 kHz	10 mA
	5 kHz	
	7.5 kHz	
	9.7 kHz	
	10 kHz	
	220 Hz	
	220 Hz	

Input		
Current, rms	Frequency	Range
100 mA	1 kHz	100 mA
	5 kHz	
	7.5 kHz	
	9.7 kHz	
	10 kHz	
	220 Hz	
	220 Hz	
1 A	1 kHz	1 A
	5 kHz	
	7.5 kHz	
	9.7 kHz	
	10 kHz	
	220 Hz	
	220 Hz	

Finishing Adjustments

- 1** Remove all shorting blocks and connections from the instrument.
- 2** Reset the Calibration Message (see [page 77](#)).
- 3** Reset the Calibration Security (see [page 75](#)).
- 4** Record the new Calibration Count (see [page 77](#)).



4 Disassembly and Repair

Operating Checklist	104
Types of Service Available	105
Repackaging for Shipment	106
Cleaning	106
To Replace the 34410A/11A Power Line Fuse	106
To Replace the Current Input Fuse	107
Self Test Procedures	107
Calibration Errors	109
34410A/11A Display and Keypad Tests	110
Electrostatic Discharge (ESD) Precautions	110
34410A/11A Mechanical Disassembly	111
L4411A Mechanical Disassembly	117
Replaceable Parts	122

This chapter will help you troubleshoot a failing multimeter. It also describes how to obtain repair service and lists replaceable assemblies.



Operating Checklist

Before returning your multimeter to Agilent for service or repair check the following items:

Is the multimeter inoperative?

- Verify that the power cord is connected to the multimeter and to ac line power.
- Verify the front panel power switch is depressed.
- 34410A/11A** Verify the power line fuse is installed.
Use a 250 V 250 mA fuse.
- 34410A/11A** Verify the power line voltage setting.

See [page 50](#)

Does the multimeter fail self-test?

- 34410A/11A** Verify the correct power line voltage is selected.
- Remove all test connections to the multimeter and run the self-test again.

Errors may be induced by ac signals present on the multimeter input terminals during self-test. Long test leads can act as an antenna causing pick-up of ac signals.

Is the multimeter's current input inoperative?

- Verify the current input fuse.

Does the multimeter fail to respond to input signals?

- 34410A/11A** Verify that the **Front/Rear** selector switch is in the correct position for the terminals you are using.

Types of Service Available

If your instrument fails during the warranty period, Agilent Technologies will repair or replace it under the terms of your warranty. After your warranty expires, Agilent offers repair services at competitive prices.

Extended Service Contracts

Many Agilent products are available with optional service contracts that extend the *covered period* after the standard warranty expires. If you have such a service contract and your instrument fails during the covered period, Agilent Technologies will repair or replace it in accordance with the contract.

Obtaining Repair Service (Worldwide)

To obtain service for your instrument (in-warranty, under service contract, or post-warranty), contact your nearest Agilent Technologies Service Center. They will arrange to have your unit repaired or replaced, and can provide warranty or repair-cost information where applicable.

To obtain warranty, service, or technical support information you can contact Agilent Technologies at one of the following telephone numbers:

In the United States: (800) 829-4444

In Europe: 31 20 547 2111

In Japan: 0120-421-345

Or use our Web link for information on contacting Agilent worldwide:

www.agilent.com/find/assist

Or contact your Agilent Technologies Representative.

Before shipping your instrument, ask the Agilent Technologies Service Center to provide shipping instructions, including what components to ship. Agilent recommends that you retain the original shipping carton for use in such shipments.

Repackaging for Shipment

If the unit is to be shipped to Agilent for service or repair, be sure to:

- Attach a tag to the unit identifying the owner and indicating the required service or repair. Include the model number and full serial number.
- Place the unit in its original container with appropriate packaging material for shipping.
- Secure the container with strong tape or metal bands.

If the original shipping container is not available, place your unit in a container which will ensure at least 4 inches of compressible packaging material around all sides for the instrument. Use static-free packaging materials to avoid additional damage to your unit.

Agilent suggests that you always insure shipments.

Cleaning

Clean the outside of the instrument with a soft, lint-free, slightly dampened cloth. Do not use detergent. Disassembly is not required or recommended for cleaning.

To Replace the 34410A/11A Power Line Fuse

The power line fuse is located within the multimeter's fuse-holder assembly on the rear panel (see [page 50](#)). The multimeter is shipped from the factory with a power-line fuse installed. The supplied fuse is a **250mAT, 250V, slow-blow, 5x20mm fuse, Agilent part number 2110-0817**. If you determine that the fuse is faulty, replace it with one of the same size and rating.

To Replace the Current Input Fuse

The front and rear current input terminals are protected by a fuse. This fuse is located on the rear panel (see [page 9](#) or [page 11](#)). The supplied fuse is a **3AT, 250V, slow-blow, 5x20mm fuse, Agilent part number 2110-0780**. If you determine that the fuse is faulty, replace it with one of the same size and rating

Self Test Procedures

Power-On Self-Test

Each time the instrument is powered on, a subset of self-tests are performed. These tests check that the minimum set of logic and output hardware are functioning properly.

34410A/11A Complete Self-Test

To perform a complete self-test on the 34410A/11A:

Press **Shift** **Data Log** (**Utility**)

UTILITY MENU > SELF-TEST

The instrument will automatically perform the complete self-test procedure. The self-test typically requires less than 10 seconds.

If the self-test is successful, SELF-TEST PASSED is displayed on the front panel.

If the self-test fails, SELF-TEST FAILED is displayed and an error number is shown. Self-test error numbers and their meaning are shown in the table on the next page. You can retrieve error messages from the queue as follows:

Press **Shift** **Data Log** (**Utility**)

UTILITY MENU > SCPI ERRORS

You can scroll through the errors using the navigation keypad.

L4411A Complete Self-Test

To perform a complete self-test on the L4411A send the *TST command from the remote interface.

Self Test Error Numbers

NOTE

On the remote interface, a self-test failure will generate SCPI error –330 and a supplemental message indicating one of the test numbers shown below. On the front panel, only the failing test is shown.

Test #	Test Name:
600	Front Panel Communications
601	Front Panel All On Test
602	A/D Feedback Test
603	Fine A/D Test
604	Fine A/D Linearity
605	A/D & FE Measure Zero
606	Input Amplifier x100 Zero Test
607	Input Amplifier x10 Zero Test
608	Input Amplifier x1 Zero Test
609	Input Leakage Test
610	Input Amplifier x10 Gain Test
611	Input Amplifier x1 Gain Test
612	Ohms 500nA Current Source
613	DC High Voltage Divider Test
614	Ohms 5 μ A Current Source Test
615	Ohms 10 μ A Current Source
616	Ohms 100 μ A to 200 Ohm Shunt
617	Ohms 1mA to 2 Ohm Shunt
618	High Current Shunt Test
619	AC 0.1VAC Zero Test
620	Precharge Amplifier Gain Test
621	Precharge Offset Range Test
622	FPGA Ping Test

Calibration Errors

The following errors indicate failures that may occur during a calibration.

Error #	Meaning
701	Calibration error; security defeated by hardware jumper
702	Calibration error; calibration memory is secured
703	Calibration error; secure code provided was invalid
704	Calibration error: secure code too long
705	Calibration error; calibration aborted
706	Calibration error: value out of range
707	Calibration error: signal measurement out of range
708	Calibration error: signal frequency out of range
709	Calibration error: no cal for this function or range
710	Calibration error: full scale correction out of range
711	Calibration error: ADC calibration failed
720	Calibration error: DCV offset out of range
721	Calibration error: DCI offset out of range
722	Calibration error: RES offset out of range
726	Calibration error: ACV offset out of range
727	Calibration error: ACI offset out of range
730	Calibration error: precharge DAC convergence failed
731	Calibration error: A/D turnover correction out of range
732	Calibration error: AC flatness calibration failed; amplitude at xxxx Hz
733	Calibration error: AC low frequency convergence failed
734	Calibration error: AC low frequency correction out of range
747	Calibration variable does not exist
748	Cal: mainframe cal memory write failure

NOTE

In error 732, "xxxx" is the frequency at which the worst AC flatness deviation was calculated.

34410A/11A Display and Keypad Tests

You can test the keypad and display.

Hold down the **Shift** key as you turn on the instrument. Hold the **Shift** key for a little over 5 seconds, until you hear a relay click. When you release the **Shift** key, the instrument begins the keypad test. The second display line shows the names of the keys. Press each key in turn, as shown. When all the keys have been pressed, the display test is available. Press the left or right arrow keys (**←** or **→**) to cycle the display through all the segments and annunciators. Press **Exit** when finished.

Electrostatic Discharge (ESD) Precautions

Electrical components can be damaged by electrostatic discharge (ESD) during handling. Component damage can occur at electrostatic discharge voltages as low as 50 volts.

The following guidelines will help prevent ESD damage when servicing the instrument or any electronic device.

- Disassemble instruments only in a static-free work area.
- Use a conductive work area to reduce static charges.
- Use a conductive wrist strap to reduce static charge accumulation.
- Minimize handling.
- Keep replacement parts in original static-free packaging.
- Remove all plastic, foam, vinyl, paper, and other static-generating materials from the immediate work area.
- Use only anti-static solder suckers.

34410A/11A Mechanical Disassembly

For procedures in this manual, the following tools are required for disassembly:

- T20 Torx driver (most disassembly)
- T15 Torx driver (fan removal)
- Flat Blade screw driver

The following tools may also be needed if further disassembly is required.

- 9/32" nut driver (rear-panel GPIB connector)

WARNING

SHOCK HAZARD. Only service-trained personnel who are aware of the hazards involved should remove the instrument covers. To avoid electrical shock and personal injury, make sure to disconnect the power cord from the instrument before removing the covers. Some circuits are active and have power applied even when the power switch is turned off.

General Disassembly

- 1 Turn off the power. Remove all cables from the instrument.
- 2 **Remove the Carry Handle.** Rotate the handle upright and pull out from the sides of the instrument.



4 Disassembly and Repair

- 3 Remove the instrument bumpers.** Pull from a corner and stretch the bumpers off the instrument.



- 4 Remove the rear bezel.** Loosen the two captive screws in the rear bezel and remove the rear bezel.

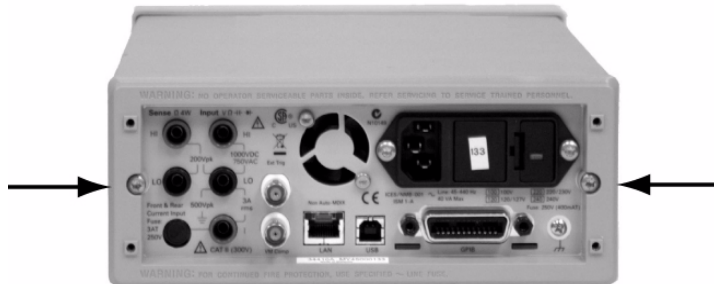

- 5 Remove the cover.** Remove the Torx drive screw in the bottom of the cover and slide the cover off the instrument.

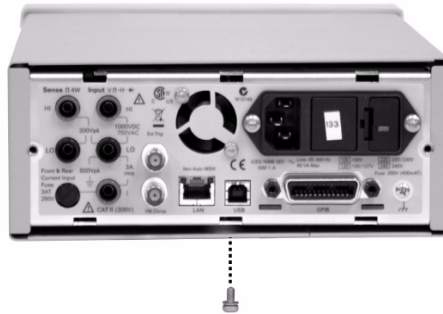

Front Panel Removal

- 6 Remove push rod and disconnect display cable.**
- a** Gently move the power switch push rod toward the front of the instrument to disengage it from the switch. Be careful not to twist or bend the push rod. Remove the front/rear push rod in the same manner.
 - b** Push down on the front panel cable connector latch and disconnect the cable from the main board.

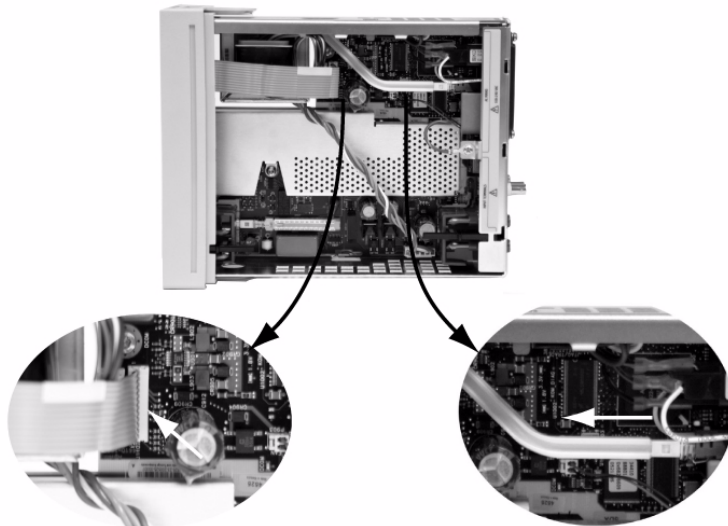

7 Remove front panel.

- a Using a small bladed screwdriver, gently pry the black terminal latch from the red terminal housing. Rotate the Terminal latch up and remove it from the instrument.

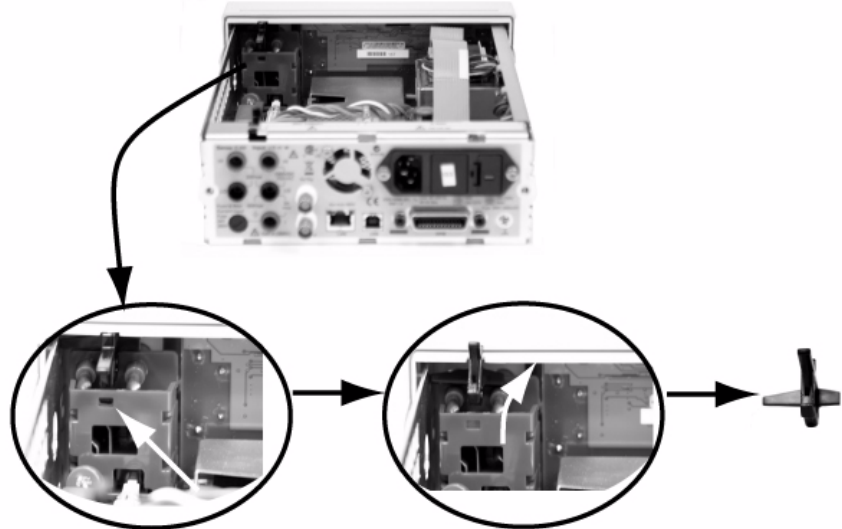

- b Remove the Torx screw holding the front panel assembly.

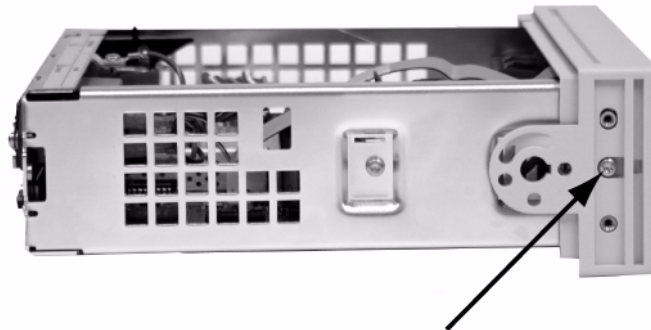

- c There is now enough play to allow the side of the front panel to be pried from the chassis and removed as an assembly.



Front Panel Disassembly

1 Remove the keypad and display assembly.

- a** Using a flat blade screwdriver, gently pry up on the circuit board tab (shown below) and slide the board to disengage from the tabs. Lift the keypad and display assembly from the plastic housing.

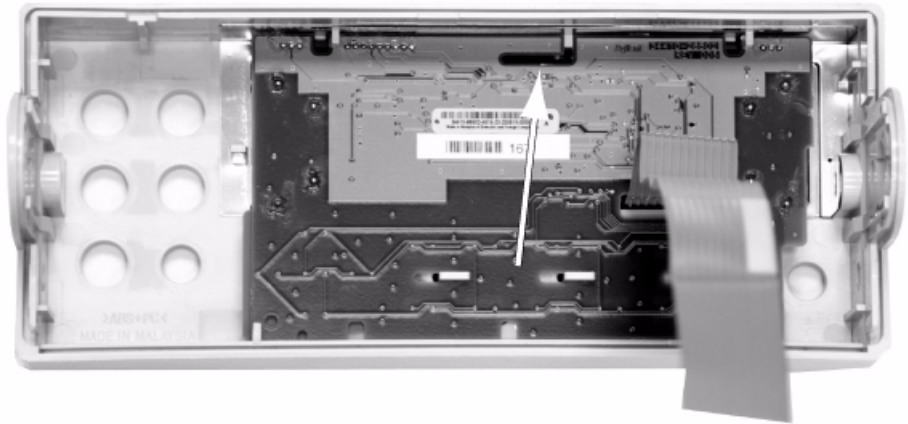

- b** The rubber keypad can now be pulled from the plastic housing.



L4411A Mechanical Disassembly

For procedures in this manual, the following tools are required for disassembly:

- T10 Torx driver (most disassembly)
- T20 Torx driver (power supply removal)
- Flat Blade screw driver

The following tools may also be needed if further disassembly is required.

- 9/32" nut driver (rear-panel GPIB connector)

WARNING

SHOCK HAZARD. Only service-trained personnel who are aware of the hazards involved should remove the instrument covers. To avoid electrical shock and personal injury, make sure to disconnect the power cord from the instrument before removing the covers. Some circuits are active and have power applied even when the power switch is turned off.

General Disassembly

- 1 Turn off the power. Remove all cables from the instrument.
- 2 **Remove the top cover and front bezel.** Remove the four Torx drive screws, two on each side of the cover and slide the cover back and off the instrument. Remove the two Torx drive screws from the front bezel and slide the bezel off the instrument.

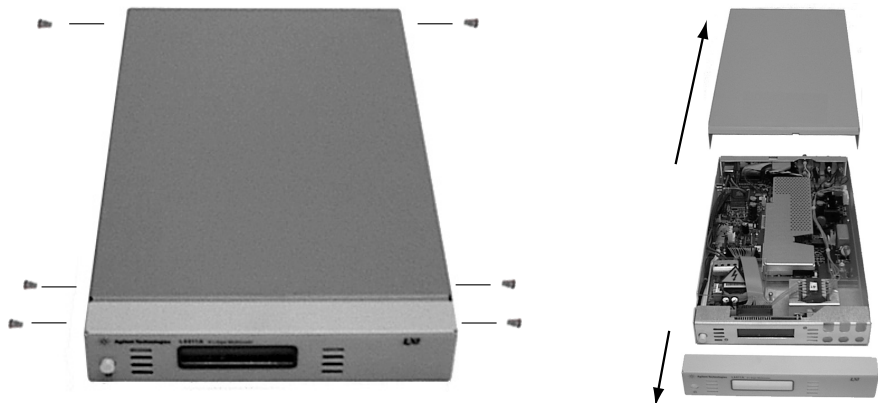

4 Disassembly and Repair

- 3 Remove the power switch push rod.** Gently move the power switch push rod toward the front of the instrument to disengage it from the switch. Be careful not to twist or bend the push rod. You will need to rotate the push rod to guide it out through the front panel.

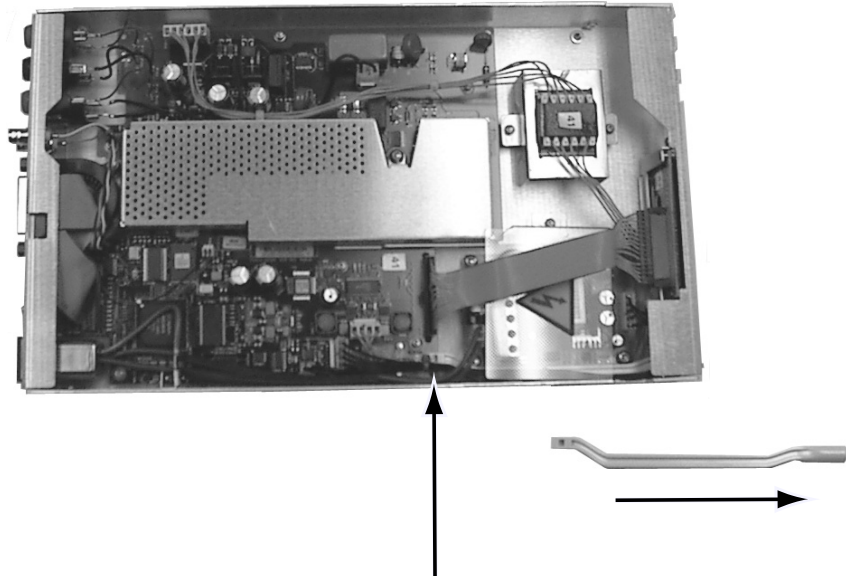

- 4 Remove the Display Cable from the main circuit board.** Release the cable connector key from the main circuit board. If desired, remove the display cable by releasing the cable connector key on the *underside* of the display assembly.

- 5 Remove the power supply safety shield.** Remove the Torx screw holding the safety shield and lift out the shield. The display cable can be flexed out of the way without removing the cable from the display assembly.

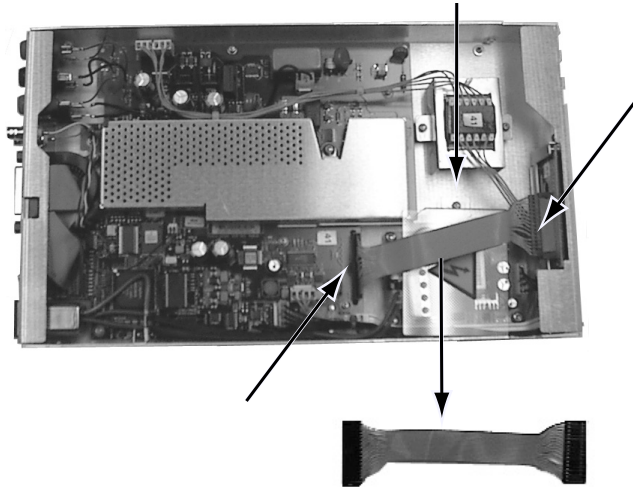

- 6 Remove the power supply input and output cables.**

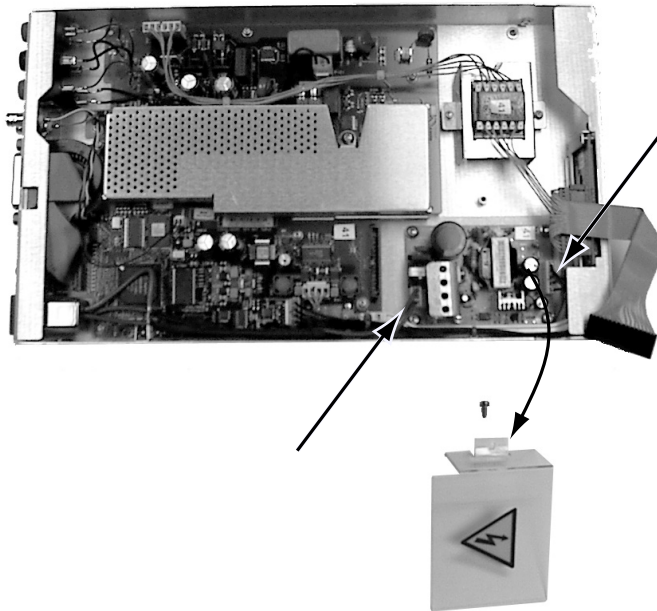

4 Disassembly and Repair

- 7 Remove the Power Supply Assembly.** Remove the four Torx screws holding the power supply assembly in place and lift out the power supply.

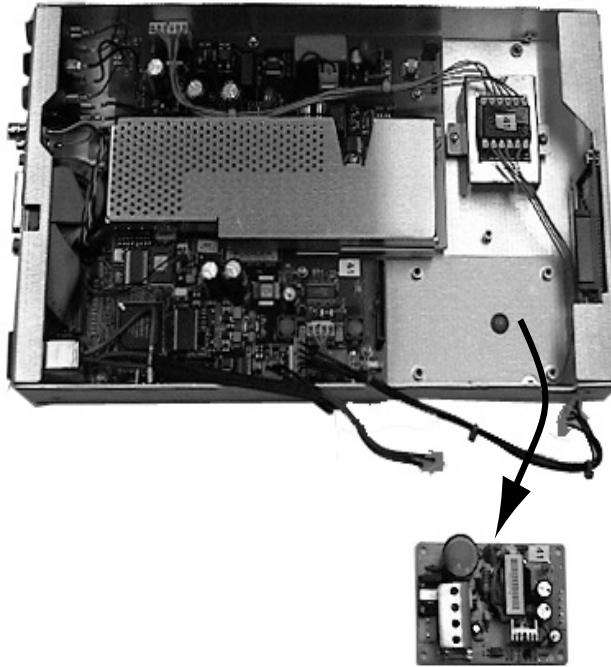

- 8 Remove the Display Assembly.** Remove the two Torx screws holding the display bracket to the front panel and lift the display assembly and bracket up and out of the instrument.

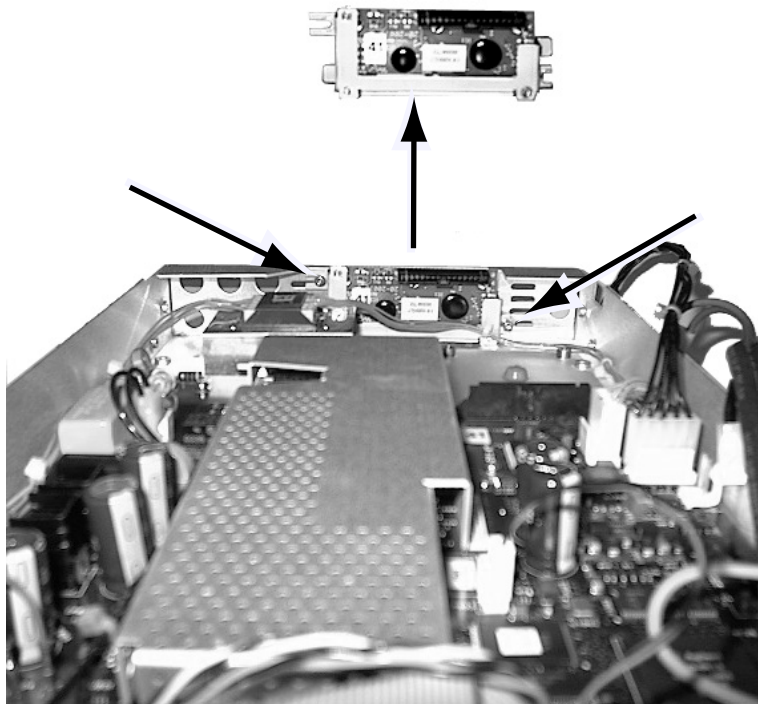

Replaceable Parts

This section contains information for ordering replacement parts for your instrument. The parts lists are divided into the following sections.

Parts are listed in alphanumeric order according to their reference designators. The parts lists include a brief description of each part with applicable Agilent part number.

To Order Replaceable Parts

You can order replaceable parts from Agilent using the Agilent part number. Note that not all parts listed in this chapter are available as field-replaceable parts. To order replaceable parts from Agilent, do the following:

- 1** Contact your nearest Agilent Sales Office or Service Center.
- 2** Identify the parts by the Agilent part number shown in the replaceable parts list.
- 3** Provide the instrument model number and serial number.

Parts List 34410A/11A

Agilent Part Number	Description
2110-0817	Line Fuse
2110-0780	Current Fuse
33220-88304	Bezel Rear
34401-45012	Latch-Terminal
34401-45021	Handle
34401-86013	Safety-Cover
34401-86020	Kit Bumper
34410-00602	Shield-Bottom
34410-00603	Shield-Top
34410-00611	Shield-ESD, VFD
34410-40201	Panel, Front
34410-43711	Pushrod-Power
34410-43712	Pushrod-Rear Terminals
34410-49321	Window 34410A
34411-49321	Window 34411A
34410-66502	PCA, Display
34410-68502	Assembly-Fan
34410-80101	Assembly-Chassis
34410-81912	Keypad
34410-84101	Cover
34401-86201	PWR-Module/Fuse Drwr and Fuse
34410-87920	Transformer-Power

4 Disassembly and Repair

Parts List L4411A

Agilent Part Number	Description
2110-0780	Current Fuse
L4411-61601	Cable, Display
L4411-04104	Power Supply Cover
L4411-04103	Front Panel
L4411-43701	Pushrod
E5810-00001	Display - LCD 36mm
E5810-00007	Bracket, Display
L4411-04102	Cover



5 Backdating

This chapter contains information necessary to adapt this manual to instruments not directly covered by the current content. At this printing, however, the manual applies to all instruments. Therefore, no information is included in this chapter.



